

Welch Allyn[®]
ELI[®] 250/ ELI[®] 210
Service Manual

Manufactured by Welch Allyn, Inc. Skaneateles Falls, NY U.S.A.



CAUTION: Use of this service manual is intended for qualified service personnel only.
CAUTION: Federal law restricts this device for sale to or on the order of a physician.

©2019 Welch Allyn This document contains confidential information that belongs to Welch Allyn, Inc. No part of this document may be transmitted, reproduced, used, or disclosed outside of the receiving organization without the express written consent of Welch Allyn, Inc.

Welch Allyn is a registered trademark of Welch Allyn, Inc

For patent information, please visit www.welchallyn.com/patents

For information about any Welch Allyn product, visit: <https://www.welchallyn.com/en/about-us/locations.html>

Customer Service and Technical Support: <https://www.welchallyn.com/en/other/contact-us.html> 1.888.667.8272,
mor_tech.support@hillrom.com



9516-163-50-ENG Rev.D
Revision Date: 2019-12



Welch Allyn, Inc.
4341 State Street Road
Skaneateles Falls, NY 13153 USA

www.welchallyn.com

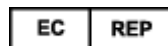

EU IMPORTER

Welch Allyn Limited
Navan Business Park, Dublin Road,
Navan, Co. Meath C15 AW22
Ireland

TABLE OF CONTENTS

NOTICES	4
RESPONSIBILITY OF THE CUSTOMER	4
EQUIPMENT IDENTIFICATION	4
COPYRIGHT AND TRADEMARK NOTICES	4
OTHER IMPORTANT INFORMATION	4
NOTICE TO EU USERS AND/OR PATIENTS:	4
WARRANTY INFORMATION	5
YOUR WELCH ALLYN WARRANTY	5
USER SAFETY INFORMATION	6
WARNING(S)	6
CAUTION(S)	8
ELECTROSTATIC CAUTION	8
EQUIPMENT SYMBOLS AND MARKINGS	10
SYMBOL DELINEATION	10
GENERAL CARE	11
SERVICE MANUAL PURPOSE	11
PERIODIC SAFETY INSPECTIONS	11
PROPER POWER CORD	11
PROPER FUSE	11
DO NOT OPERATE IN EXPLOSIVE ATMOSPHERES	11
USE ONLY SAFE METHODS OF INTERCONNECTION	11
DO NOT MOUNT PRODUCT ABOVE PATIENT	11
RECOMMENDED ACCESSORIES	11
STERILIZING THIS PRODUCT	12
LIQUID SPILLS	12
DISPOSAL	12
MAINTENANCE AND CLEANING	13
INTRODUCTION	13
RECOMMENDED CLEANING SUPPLIES	13
EQUIPMENT REQUIRED	13
CLEANING AND INSPECTING TECHNIQUES	14
INTERIOR CLEANING	14
MAGNETIC CLEANING	14
.....	14
PRINTED CIRCUIT BOARD CLEANING	14
METALLIC AND PLASTIC PARTS CLEANING	15
EXTERIOR CLEANING	15
PRINthead CLEANING	15
INSPECTION OF WRITER ASSEMBLY HARNESS	15
EXTERIOR INSPECTION	16
INTERIOR VISUAL INSPECTION	16
PREVENTATIVE MAINTENANCE SCHEDULE:	16
SYSTEM SETTINGS	17
CHAPTER PURPOSE	17
ACCESS CONFIGURATION MENUS	17

SUMMARY OF CONFIGURATION MENUS	20
CONFIGURATION PAGE1	23
CONFIGURATION PAGE2	25
CONFIGURATION PAGE3	28
CONFIGURATION PAGE4	30
CONFIGURATION PAGE5	31
CONFIGURATION PAGE 6 (OPTIONAL LAN CONNECTIVITY)	32
CONFIGURATION PAGE 6, CONTINUED (OPTIONAL WLAN CONNECTIVITY)	33
CONFIGURATION PAGE 7(OPTIONAL WLAN CONNECTIVITY, CONTINUED)	34
ACCESS CONFIGURATION MENUS FOR THE ELI 210	35
SUMMARY OF CONFIGURATION MENUS	37
CONFIGURATION PAGE1	39
CONFIGURATION PAGE2	41
CONFIGURATION PAGE3	43
ASSEMBLY/DISASSEMBLY OF UNIT	44
FUSE REMOVAL.....	44
COVER ASSEMBLYREMOVAL / INSTALLATION	45
BATTERY REMOVAL.....	50
KEYBOARD/LCD REMOVAL	50
WRITER REMOVAL / INSTALLATION	54
PRINtheadREMOVAL / INSTALLATION	56
WRITER MOTOR REMOVAL / INSTALLATION	58
PRINTED CIRCUIT BOARD ASSEMBLY REMOVAL / INSTALLATION	60
FRONT END BOARD REMOVAL AND REPLACEMENT	62
TECHNICAL DESCRIPTION	64
INTRODUCTION	64
ELI 250/210 BLOCK DIAGRAM	65
MAIN SYSTEMBOARD	66
FRONT ENDBOARD	67
SPECIFICATIONS	68
PARTS LIST	69
HARDWARE.....	70
TROUBLESHOOTING AND TESTING	71
INTRODUCTION	71
TROUBLESHOOTING	71
TESTING	73
ELI250/210 TEST DATA RECORD.....	84
APPENDIX A ELI 250 CONNECTIVITY.....	85
CHAPTERPURPOSE	85
DIRECT CONNECTION	87
MODEM TRANSMISSION.....	87
MODEM INITIALIZATION	87
WLAN TRANSMISSION.....	89
LAN TRANSMISSION	90
PATIENT REQUESTLIST.....	95
APPENDIX B ELI 250 CONNECTIVITY OPTIONS.....	99
MODEM OPTIONS	99
XIRCOM MODEM.....	99
XIRCOM MODEM REMOVAL	100
MULTITECH MODEM	101

MULTITECH MODEM REMOVAL 101
LAN OPTION..... 103
LAN CARD REMOVAL..... 103
REMOVAL OF THE LAN INTERFACE BOARD, ITEM#58..... 104
LAN CARD INTERCONNECT CABLES. 105
WIRELESS LAN OPTION..... 106
WIRELESS LAN CARD (WLAN) REMOVAL..... 107

NOTICES

Manufacturer's Responsibility

Welch Allyn, Inc., is responsible for the effects on safety and performance only if:

- Assembly operations, extensions, readjustments, modifications or repairs are carried out only by persons authorized by Welch Allyn, Inc.
- The device (ELI 250/210) is used in accordance with the instructions for use.

Responsibility of the Customer

The user of this product is responsible for ensuring the implementation of a satisfactory maintenance schedule. Failure to do so may cause undue failure and possible health hazards.

Equipment Identification

Welch Allyn, Inc. equipment is identified by a serial and reference number on the back of the device. Care should be taken so that these numbers are not defaced.

Copyright and Trademark Notices

This document contains information that is protected by copyright. All rights are reserved. No part of this document may be photocopied, reproduced or translated to another language without prior written consent of Welch Allyn, Inc.

Other Important Information

The information in this document is subject to change without notice.

Welch Allyn, Inc. makes no warranty of any kind with regard to this material including, but not limited to, implied warranties of merchantability and fitness for a particular purpose. Welch Allyn, Inc. assumes no responsibility for any errors or omissions that may appear in this document. Welch Allyn Inc. makes no commitment to update or to keep current the information contained in this document.

Notice to EU Users and/or Patients:

Any serious incident that has occurred in relation to the device, should be reported to the manufacturer and the competent authority of the Member State in which the user and/or patient is established.

WARRANTY INFORMATION

Your Welch Allyn Warranty

WELCH ALLYN, INC. (hereinafter referred to as “Welch Allyn”) hereby warrants that Welch Allyn products (hereinafter referred to as “Products”) shall be free from defects in material and workmanship under normal use, service and maintenance for the warranty period of such Product from Welch Allyn or an authorized distributor or representative of Welch Allyn. Normal use, service and maintenance means operation and maintenance in accordance with appropriate instructions and/or information guides. This Warranty does not apply to damage to the Products caused by any or all of the following circumstances or conditions:

- a) Freight damage;
- b) Parts and/or accessories of the Products not obtained from or approved by Welch Allyn;
- c) Misapplication, misuse, abuse and failure to follow the Product instruction sheets and/or information guides;
- d) Accident, a disaster affecting the Products;
- e) Alterations or modifications to the Products not authorized by Welch Allyn;
- f) Other events outside of Welch Allyn’s reasonable control or not arising under normal operating conditions.

THE REMEDY UNDER THIS WARRANTY IS LIMITED TO THE REPAIR OR REPLACEMENT WITHOUT CHARGE FOR LABOR OR MATERIALS, OR ANY PRODUCTS FOUND UPON EXAMINATION BY WELCH ALLYN TO HAVE

BEEN DEFECTIVE. This remedy shall be conditioned upon receipt of notice by Welch Allyn of any alleged defects promptly after discovery thereof within the warranty period. Welch Allyn’s obligations under the foregoing warranty will further be conditioned upon the assumption by the purchaser of the Products (i) of all carrier charges with respect to any Products returned to Welch Allyn’s principal place or any other place as specifically designated by Welch Allyn or an authorized distributor or representative of Welch Allyn, and (ii) all risk of loss in transit. It is expressly agreed that the liability of Welch Allyn is limited and that Welch Allyn does not function as an insurer. A purchaser of a Product, by its acceptance and purchase thereof, acknowledges and agrees that Welch Allyn is not liable for loss, harm or damage due directly or indirectly to an occurrence or consequence there from relating to the Products. If Welch Allyn should be found liable to anyone under any theory (except the expressed warranty set forth herein) for loss, harm or damage, the liability of Welch Allyn shall be limited to the lesser of the actual loss, harm or damage, or the original purchase price of the Product when sold.

EXCLUDED FROM THE LIMITED WARRANTY SET FORTH ABOVE ARE CONSUMABLE ITEMS SUCH AS PAPER, BATTERIES, ELECTRODES, PATIENT CABLES, LEAD WIRES AND MAGNETIC STORAGE MEDIUMS.

EXCEPT AS SET FORTH HEREIN WITH RESPECT TO REIMBURSEMENT OF LABOR CHARGES, A PURCHASER’S SOLE EXCLUSIVE REMEDY AGAINST WELCH ALLYN FOR CLAIMS RELATING TO THE PRODUCTS FOR ANY AND ALL LOSSES AND DAMAGES RESULTING FROM ANY CAUSE SHALL BE THE REPAIR OR REPLACEMENT OF DEFECTIVE PRODUCTS TO THE EXTENT THAT THE DEFECT IS NOTICED AND WELCH ALLYN IS NOTIFIED WITHIN THE WARRANTY PERIOD. IN NO EVENT, INCLUDING THE CLAIM FOR NEGLIGENCE, SHALL WELCH ALLYN BE LIABLE FOR INCIDENTAL, SPECIAL OR CONSEQUENTIAL DAMAGES, OR FOR ANY OTHER LOSS, DAMAGE OR EXPENSE OF ANY KIND, INCLUDING LOSS OF PROFITS, WHETHER UNDER TORT, NEGLIGENCE OR STRICT LIABILITY THEORIES OF LAW, OR OTHERWISE. THIS WARRANTY IS EXPRESSLY IN LIEU OF ANY OTHER WARRANTIES, EXPRESS OR IMPLIED, INCLUDING, BUT NOT LIMITED TO THE IMPLIED WARRANTY OF MERCHANT ABILITY AND THE WARRANTY OF FITNESS FOR A PARTICULAR PURPOSE.

USER SAFETY INFORMATION



WARNING:

Means there is the possibility of personal injury to you or others.



Caution:

Means there is the possibility of damage to the equipment.



Electrostatic Caution

Means that there is the possibility of damage due to electrostatic discharge and appropriate precautions should be taken.

Note:

Provides information to further assist in the use of the device.

Federal law restricts this device for sale to or on the order of a physician.



WARNING(S)

- Device (electrocardiograph, Class I) captures and presents data reflecting a patient's physiological condition that when reviewed by a trained physician or clinician can be useful in determining a diagnosis. However, the data should not be used as a sole means for determining a patient's diagnosis.
- To ensure that electrical safety is maintained during operation from AC (~) power, the device must be plugged into a Hospital Grade outlet.
- To maintain designed operator and patient safety, peripheral equipment and accessories used that can come in direct patient contact, must be in compliance with UL2601-1, IEC 601-1 and IEC 601-2-25.
- Patient cables intended for use with the ELI250/210 include series resistance (10 Kohm minimum) in each lead for defibrillation protection. Patient cables should be checked for cracks or breakage prior to use.
- Conductive parts of the patient cable, electrodes and associated connections of Type CF applied parts, including the neutral conductor of the patient cable and electrode should not come into contact with other conductive parts, including earth ground.
- To maintain designed operator and patient safety, only use parts and accessories supplied with the device and available through Welch Allyn, Inc.
- ECG electrodes could cause skin irritation and should be examined for signs of irritation or inflammation.
- To prevent possible infection, single use components (e.g., electrodes) should be limited to one-time use only.
- To avoid the possibility of serious injury or death during patient defibrillation, do not come into contact with device or patient cables. Additionally, proper placement of defibrillator paddles in relation to the electrodes is required to minimize harm to the patient.
- To ensure the safety of both the patient and the device, 1.5 meters (5 feet) of open area should surround the patient.
- A possible explosion hazard exists; do not use the device in the presence of flammable anesthetics.

- Before attempting to use the device for clinical applications the operator must read and understand the contents of the manual and any documents accompanying the device.
- Where the integrity of external protective earth conductor arrangement is in doubt, the ELI250/210 shall be operated from its internal electrical power source.
- All signal input and output(I/O) connectors are intended for connection of only devices complying with IEC 60601-1, or other IEC standards (e.g. IEC 60950), as appropriate to the device. Connecting additional devices to the ELI 250/210 may increase chassis and/or patient leakage currents. To maintain operator and patient safety, consideration should be given to the requirements of IEC 60601-1-1, and leakage currents should be measured to confirm no electric shock hazard exists.
- The ELI 250/210 has not been designed for use with high-frequency (HF) surgical equipment and does not provide a protective means against hazards to the patient.
- The quality of the signal produced by the electrocardiograph may be adversely affected by the use of other medical equipment, including but not limited to defibrillators and ultrasound machines.
- The ELI 250/210 uses a lead-acid gel cell battery. Disposal of this battery must be in compliance with governmental regulations.
- This unit can operate using AC power. Caution should be taken when working on this unit to limit the exposure to high voltages. The unit should not be connected to AC power and the battery fuse should be removed when replacing any assembly of this unit.



Caution(s)

- To prevent possible damage to the keypad, do not use sharp or hard objects to depress keys, only use fingertips.
- Do not attempt to clean the device or patient cables by submersing into a liquid, autoclaving, or steam cleaning. Wipe the exterior surfaces with a warm water and mild detergent solution and then dry with a clean cloth.
- No user serviceable parts inside. Screw removal by qualified service personnel only.
- The rechargeable internal battery is a sealed lead acid type and it is totally maintenance free. If the battery appears to become defective, refer to Welch Allyn Service Department.
- Do not pull or stretch patient cables as this could result in mechanical and/or electrical failures. Patient cables should be stored after forming them into a loose loop.



Electrostatic Caution

Notes

- Excessive patient movement could interfere with the operation of the device.
- Proper patient preparation is important to proper application of ECG electrodes and operation of the device.
- There is no known safety hazard if other equipment, such as pacemakers or other stimulators, are used simultaneously with the ELI 250/210; however, disturbance to the signal may occur.
- If the ECG amplifier input is out of normal operating range, the display will indicate a lead fail for the lead(s) where this condition is present and if the signal is being printed, the respective lead(s) will print out as a square wave.

- As defined by IEC 60601-1 and IEC 60601-2-25, the device is classified as follows:
 - Class I equipment or internally powered
 - Type CF applied parts
 - Ordinary equipment
 - Not suitable for use in the presence of flammable anesthetics
 - Continuous operation

NOTE: From a safety perspective, per IEC 60601-1 and derivative standards / norms, this unit is declared to be "Class I" and uses a three-prong inlet to ensure an earth connection is made along with mains. The ground terminal on the mains inlet is the only protective earth point in the unit. Exposed metal accessible during normal operation is double insulated from mains. Internal connections to earth ground are functional earth.

- The ELI 250/210 will automatically turnoff (blank screen) if the batteries have been severely discharged.
- After operating the ELI 250/210 using battery power, always reconnect the power cord. This ensures that the batteries will be automatically recharged for the next time you use the ELI 250/210. A light will illuminate, next to the on/off switch, indicating that the unit is charging.
- The ELI 250/210 is a UL Classified Device:



WITH RESPECT TO ELECTRIC SHOCK,
FIRE AND MECHANICAL HAZARDS ONLY IN ACCORDANCE WITH
IEC 60601-1, CAN/CSA C22.2 No. 60601-1, AND
IEC 60601-2-25

EQUIPMENT SYMBOLS AND MARKINGS

Symbol Delineation



CAUTION The caution statements in this manual identify conditions or practices that could result in damage to the equipment or other property, or loss of data.



WARNING The warning statements in this manual identify conditions or practices that could lead to illness, injury, or death. In addition, when used on a patient applied part, this symbol indicates defibrillation protection is in the cables. Warning symbols will appear with a grey background in a black and white document.



Electrostatic sensitive devices



Do not dispose as unsorted municipal waste. Requires separate handling for waste disposal according to local requirements.



Indicates compliance to applicable European Union directives



Follow instructions/directions for use (DFU) – mandatory action. A copy of the DFU is available on this website. A printed copy of the DFU can be ordered from Welch Allyn for delivery within 7 calendar days.



Medical Device



Reorder Number

GENERAL CARE

Service Manual Purpose

The purpose of this manual is to supply information to service personnel so they can maintain the ELI 250/210 Interpretive and Non-Interpretive Electrocardiograph at the assembly and subassembly level. Although the manual includes parts lists, mechanical assembly parts, and printed circuit board information, it is intended to function primarily as a guide to preventative and corrective maintenance and electrical repairs considered field repairable.

Periodic Safety Inspections

Follow the recommended maintenance schedule. Inspect the power cord and transmission cables periodically for fraying or other damage and replace as needed. Broken or frayed wires may cause interference or loss of signal. Pay particular attention to points where wires enter connectors.

Proper Power Cord

Use only the power cord specified for the equipment. This product requires a three-wire, (18 gauge, SJT-grade) power cord, which is supplied with a three-terminal, polarized plug (hospital grade) for connection to the power source and protective ground. Use only a power outlet with a protective ground outlet. An interruption of the grounding connection could cause an electrical shock hazard.

Proper Fuse

Use only the fuse specified for the equipment (identical in type, voltage and current rating). Substituting a different fuse type could cause a fire hazard. Always make sure fuses have been installed before operating the unit.

Do Not Operate in Explosive Atmospheres

Do not operate the ELI250/210 in the presence of flammable gasses or anesthetics; this environment could cause an explosion. Refer to Operator's Manual Safety Information: Warning(s) and Caution(s).

Use Only Safe Methods of Interconnection

To prevent electrical shock from the product when it is connected to other electrical equipment, proper grounding is essential. Refer to Operator's Manual Safety Information: Warning(s) Peripheral equipment.

Do Not Mount Product above Patient

Do not mount or place the product where it could fall on a patient or where it could be accidentally knocked off a shelf or other mounting arrangement.

Recommended Accessories

For the patient's safety and optimum equipment performance, use only the accessories specified by Welch Allyn, Inc.

Sterilizing this Product

Do not sterilize this product or any accessories unless specifically directed by the manufacturer. Sterilization and sterilization environments can seriously damage many components and accessories.

Liquid Spills

Do not set beverages or other liquids on or near the ELI 250/210, and/or optional equipment.

Disposal

This product and its accessories must be disposed of according to local laws and regulations. Do not dispose of this product as unsorted municipal waste. For more specific disposal information see www.welchallyn.com/weee.

MAINTENANCE AND CLEANING



CAUTION:

Remove battery fuse before attempting any disassembly.

Removal of the battery fuse will not cause a loss of ECGs or of the configuration. This information is stored in FLASH memory.

Introduction

This section provides servicing and maintenance instructions for the ELI 250/210 interpretive electrocardiograph. Subsequent parts of this section are disassembly, inspection techniques, cleaning techniques, and installation.

Recommended Cleaning Supplies



- Anti-static mat & wrist band, properly grounded
- Clean, lint-free cloth
- Cleaning solvent (isopropyl alcohol, 99% pure)
- DRY, low pressure, compressed air (30 psi)
- Electronic safe non-residue solvent, such as Flux-off
- Masking tape
- Non-metallic, soft-bristle brush
- Naphtha
- Vacuum cleaner, Static Safe

Equipment Required

- Screwdriver Philips #2.
- Allen Wrench 0.05 inch or a 1.25 mm
- Vibra-Tite or similar product to prevent screws from vibrating loose.
- Digital Multi Meter (DMM)

Note: The equipment and solvent mentioned above are standard shop commodities that are available from commercial sources. If in the performance of normal maintenance or repair, the PCB assembly, AC connector assembly, or writer assemblies are removed or replaced, a leakage test should be performed. See section on testing.

Cleaning and Inspecting Techniques

This section contains instructions for periodic cleaning and inspection of the instrument as preventative maintenance measures. It also contains specific cleaning procedures to be conducted after disassembly. Parts having identical cleaning procedures are grouped under common headings. No special tools are required.

Interior Cleaning



WARNING

Ventilate work area thoroughly when using solvents. Observe manufacturers warnings on solvent containers with regard to personnel safety and emergency first aid. Be sure that first aid equipment is available before using chemicals. Observe all shop safety and fire precautions.

Magnetic Cleaning



CAUTION

Do not use solvents to clean transformers or inductors. The chemical action of solvents may remove the varnish from the wire coils, rendering the components useless. The solvent also neutralizes the adhesive of the cover tape, resulting in eventual tape separation from the windings.

Clean transformers and inductors with a dry, non-metallic, soft bristle brush.

Printed Circuit Board Cleaning



The printed circuit board assemblies in the ELI 250/210 system contain static sensitive devices. Use special handling procedures to prevent damage due to ESD.

Clean assembled parts with a vacuum cleaner or low pressure compressed air (30 psi). Take care when cleaning printed circuit boards that wires or component leads are not bent back and forth in such a manner as to weaken them and cause them to eventually break.

Dry with low pressure compressed air.

Metallic and Plastic Parts Cleaning



CAUTION

Do not wipe over surfaces of nameplates or labels with abrasive cleaners or materials, as this will eventually wear away the nameplate information. Do not use solvents to clean plastic parts.

Brush all surfaces and parts with a nonmetallic, soft bristle brush.

Wipe metal surfaces with soft, nonabrasive cloth dampened with isopropyl alcohol. Dry surfaces with clean cloth.

Wipe surfaces of nameplates and labels with dry cloth.

Exterior Cleaning

Use a damp cloth to clean external covers and the line cord. Do not use alcohol, solvents, or cleaning solutions. These cleaning agents may damage the surfaces of the instrument.

Printhead Cleaning

Open the writer cover as explained in the section on final assembly.

Apply isopropyl alcohol to a clean cloth and wipe the writer printhead until all foreign matter is removed. Dry the printhead thoroughly before use. Use a dry clean cloth for this.

After cleaning is completed, inspect the unit using the techniques described previously.

After the inspection is complete, install the cover as explained in the section on final assembly.

Inspection of Writer Assembly Harness

Visually inspect the wire harnesses for wear, maintenance damage, corrosion, deterioration, and damage resulting from dropping.

If no defects are found, install the cover and restore the unit to service.

If a defect is found in the cables, replace the damaged cable with a new cable.

Exterior Inspection

Visually inspect the entire instrument for wear, maintenance damage, corrosion, deterioration, and damage resulting from dropping.

Interior Visual Inspection

Check all connectors for loose, bent or corroded contact points. Check wire, harnesses and cables for signs of wear or deterioration.

Inspect components and their leads for security of mounting, deterioration or leakage.

Check terminals and connections for proper installation, failed soldering, loss or wear.

Inspect PCB surfaces for charring, cracking or brittleness.

Note: Some degree of discoloration of the PCB surface maybe expected due to continued exposure to the operating temperatures of some of the components.

Check the identification nameplate and other decals for legibility.

Inspect chassis, covers, and brackets for warping, bending, surface damage or missing captive hardware.

Check all screws and nuts for tightness or signs of stripped or crossed threads.

Check for any other form of mechanical damage, which may indicate a failure.

If, during the process of normal maintenance or repair, the PCB assembly, AC connector assembly, or writer assembly are removed and replaced, perform the leakage test as described in the section on Testing and Troubleshooting.

Preventative Maintenance Schedule:

Maintenance to be Performed	Period	Notes
Clean and inspect unit.	6 mo.	Perform every 3 mo. if unit is in heavy use.
Printhead cleaning	80 hrs.	Monthly cleaning recommended
Leakage tests.	-	As required by facility or regulatory requirements.

Table 1

SYSTEM SETTINGS

Chapter Purpose

This chapter is intended to provide the user with:

- Instructions to access configuration menus
- Summary of configuration options
- Detailed descriptions of configuration settings

Access Configuration Menus

Four configuration pages define all ELI 250 operational conditions that do not change on a daily or patient-to-patient basis. Once you set these default conditions, you will rarely need to use the configuration screens again. When you apply power to the ELI250, it will operate according to the settings you have selected. To access the configuration menus:

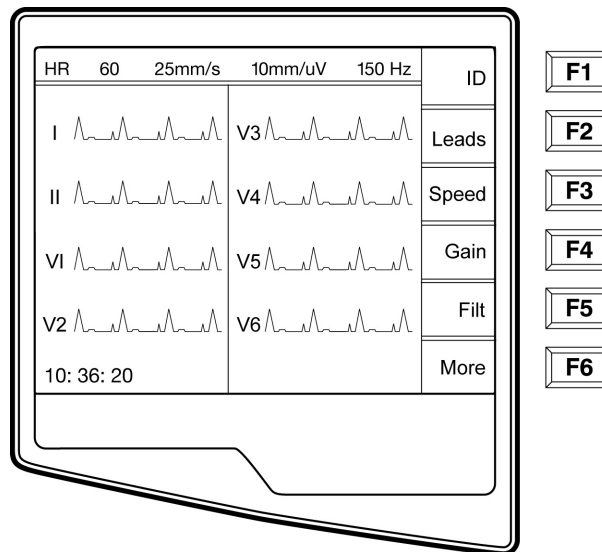

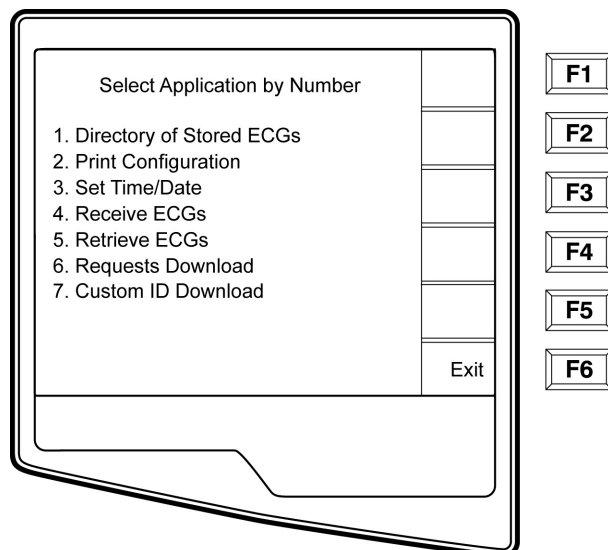

- ☐ Select **More (F6)** from the Real-Time ECG View.

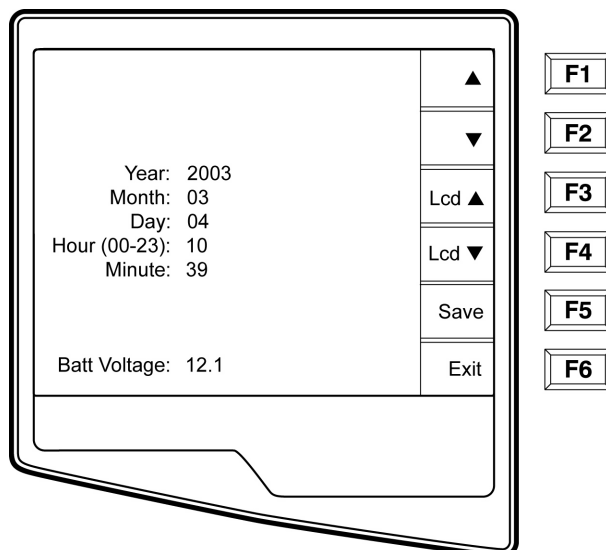

Select **Set Time/Date** (number 3) from the application menu



☒ From the Set Time/Date screen, simultaneously press   **(SHIFT) + ALT + C**. The first configuration screen will appear. Notice the page indicator in the upper right hand corner on each screen.

Modify Configuration Page 1/6		▲	F1
Software Version	1.10	▼	F2
Cart Number	0		F3
Site Number	0		F4
Site Name	Mortara Instrument		F5
Tel No	OW1414354999	Page	F6
Language	English		
Volume	2		
Battery Time Out	10 Min	Exit	

NOTES: Use **Page (F4)** to toggle through the configuration pages.
 Use **▲ (F1)** and **▼ (F2)** to move back and forth through each configuration option.
 Use **► (F3)** to toggle through pre-programmed available settings per configuration field.
 Use **Exit (F6)** to return to the Real-Time ECG View. Any changes you have made will be saved. Use the **BACKSPACE** key to erase entry errors.

The following chart summarizes the configuration screens and the available options for each parameter.

Summary of Configuration Menus

Configuration Parameter	Definition	Configuration Screen
Software Version	The firmware version of the unit	Screen One
Cart Number	User-defined (4 digits)	Screen One
Site Number	User-defined (4 digits)	Screen One
Site Name	User-defined (up to 30 alphanumeric characters)	Screen One
Telephone Number	User-defined (up to 30 alphanumeric characters)	Screen One
Language	Firmw are language availability	Screen One
Volume	Range from 0 – 8	Screen One
Battery Timeout	10min, 30min, 60min	Screen One
Flash Size	Normal memory or Expanded memory (optional)	Screen Two
ID Format	Short, Long, Standard, Custom (optional)	Screen Two
AC Filter	None, 60Hz, 50Hz	Screen Two
Paper Speed	25mm/sec or 50 mm/sec	Screen Two
Filter	40Hz, 150Hz, or 300Hz	Screen Two
Height/Weight Units	lb/in or kg/cm	Screen Two
Date Format	US (mm/dd/yyyy) or European (dd.mm.yyyy)	Screen Two
Plot Format	Channels printed: 3+1, 6, 3+3, 12, 6+6; Cabrera or Standard	Screen Two
Interpretation	Yes or No	Screen Two
Reasons	Yes or No	Screen Two
Append	Unconfirmed Report, Reviewed by, Blank	Screen Three
#of copies	0 - 9	Screen Three
#ECGs retrieved	0 - 9	Screen Three

Configuration Parameter	Definition	Configuration Screen
Delete Rule	Post plot, post transmit, post plot/xmt	Screen Three
Storage Sensitivity	Normal or High	Screen Three
Auto-save ECG	Yes or No	Screen Three
Auto-print ECG	Yes or No	Screen Three
Baud Rate	Serial Baud Rates: 9600, 19200, 38400, 57600, or 115200	Screen Three
Use A4 paper	Yes or No	Screen Three
Caps Lock	Yes or No	Screen Three
Rhythm format	3 channel, 6 channel or 12 channel	Screen Four
3 Rhythm Lead 1	V1-V6, I, II, III, aVR, aVL, aVF	Screen Four
3 Rhythm Lead 2	V1-V6, I, II, III, aVR, aVL, aVF	Screen Four
3 Rhythm Lead 3	V1-V6, I, II, III, aVR, aVL, aVF	Screen Four
6 Rhythm Lead 1	V1-V6, I, II, III, aVR, aVL, aVF	Screen Four
6 Rhythm Lead 2	V1-V6, I, II, III, aVR, aVL, aVF	Screen Four
6 Rhythm Lead 3	V1-V6, I, II, III, aVR, aVL, aVF	Screen Four
6 Rhythm Lead 4	V1-V6, I, II, III, aVR, aVL, aVF	Screen Four
6 Rhythm Lead 5	V1-V6, I, II, III, aVR, aVL, aVF	Screen Four
6 Rhythm Lead 6	V1-V6, I, II, III, aVR, aVL, aVF	Screen Four
3 + 1 Rhythm Lead	V1-V6, I, II, III, aVR, aVL, aVF	Screen Five
3 + 3 Rhythm Lead 1	V1-V6, I, II, III, aVR, aVL, aVF	Screen Five

3 + 3 Rhythm Lead 2	V1-V6, I, II, III, aVR, aVL, aVF	Screen Five
3 + 3 Rhythm Lead 3	V1-V6, I, II, III, aVR, aVL, aVF	Screen Five
Default XMT Media	RS232, Modem, WLAN, LAN	Screen Six
DHCP (LAN only)	Yes or No	Screen Six
IP Address	XXX.XXX.XXX.XXX	Screen Six
Default Gateway	XXX.XXX.XXX.XXX	Screen Six
Sub Net Mask	XXX.XXX.XXX.XXX	Screen Six
Host IP	XXX.XXX.XXX.XXX	Screen Six
Port Number	XXX.XXX.XXX.XXX	Screen Six
SSID	Yes or No	Screen Six
Channel Number	0, 1, 2, 3.....	Screen Six
Security WEP	Yes or No	Screen Seven
WEP Key	0, 1, 2, 3.....	Screen Seven
WEP Key ID	26 digits in 13 sets of two digits	Screen Seven

Configuration Page1

Modify Configuration Page 1/6		▲	F1
Software Version	1.10	▼	F2
Cart Number	0	▶	F3
Site Number	0	Page	F4
Site Name	Mortara Instrument		F5
Tel No	OW1414354999	Exit	F6
Language	English		
Volume	2		
Battery Time Out	10 Min		

Software Version

The displayed number identifies the firmware version of your electrocardiograph.

Cart Number

Cart numbers indicate which electrocardiograph transmitted a particular ECG.

Site Number

This option identifies the site of your ELI 250. Site numbers designate the hospital, clinic, or institution for ECG records stored in a Welch Allyn, E-Scribe data management system and must be defined for transmitting and retrieving ECGs from the data management system. You can use up to four digits for the site number, numbers from 0 –4095 are supported.

Site Name

This option defines your clinic, hospital, or office name. You can enter up to 30 alphanumeric characters. The site name prints at the bottom, left edge of the ECG printout.

Telephone Number

This option specifies the telephone number for modem transmission (to another unit or to an E-Scribe data management system). Enter up to 30 alphanumeric characters, and use the **BACKSPACE** key to erase entry errors.

To wait for an additional dial tone, use the letter **W**. For example, you may need to dial a **9** to get an outside line.



EXAMPLE: 9W14145554321

To insert a pause use a comma (,).

To change tone dialing to pulse dialing, use the letter

P. EXAMPLE: P14145554321

(If necessary, you can use both the letter W and the letter P in the same phone number.)





TIP: Instead of entering the configuration menus, use a shortcut to quickly delete or modify a phone number. From the application screen, simultaneously press   (**SHIFT**) + **ALT** + **P**. **To edit an existing number, use the tab key.**

Language

There are several languages available on the cardiograph.

CAUTION: upon selecting a new language and exiting the configuration screen, function labels are immediately translated.

If an unknown language is visible, use the following steps to revert to the language of your country:

1. **F6** from Real-Time ECG View
2. Select number **3**
3. Simultaneously press   (**SHIFT**) + **ALT** + **C**
4. Press **F2** () four times
5. Press **F3** () until the desired language appears
6. **F6** to return to Real-Time ECG View

Volume

This option defines the keyboard click loudness. Available settings range from 0 (off) to 8 (loud).

TIP: Use the **BACKSPACE**  key to erase entry errors

Battery Timeout

This setting determines when the cardiograph will switch off in order to conserve the battery life of the unit. The battery timeout will only occur if the keypad has not been depressed for the time specified. The battery timeout setting is ignored if an active ECG signal is detected, during transmission, or while rhythm printing.

Configuration Page2

Modify Configuration Page 2/6		▲	F1
Flash Size:	Normal	▼ <td>F2</td>	F2
ID Format	Short	▶ <td>F3</td>	F3
AC Filter	60 Hz	Page	F4
Paper Speed	25 mm/s		F5
Filter	150 Hz		F6
Ht/Wt Units	lb/in		
Date Format	MM/DD/YYYY		
Plot Format	3+1 Channel		
Interp	On	Exit	
Reasons	On		

Flash Size

Flash Size indicates the ECG storage capacity of your electrocardiograph. Normal Flash Size is the standard memory capacity. If the optional expanded memory has been installed, Expanded will be displayed.

ID Format

This option defines the format for the patient ID information prompts. There are three standard formats: short, standard, or long. A custom ID format is optional when downloaded from the E-Scribe Data Management System.

The short format includes the patient's last name and first name, patient ID number, date of birth, which will automatically calculate the age, and gender field.

The standard format includes the patient's last name, patient ID number, age, height, weight, gender, race, medication 1, medication 2, and a location field.

The long format is identical to the standard format except that it includes the patient's first name, room and comment fields.

The custom format, which is designed in the Welch Allyn E-Scribe Data Management System, can be downloaded to the ELI 250. The custom ID format is uniquely designed to meet your facility's needs. Please see Appendix A to download a Custom ID.

AC Filter

The ELI 250 removes 60Hz or 50Hz interference. The setting you select depends on the line frequency in your country. Always use the 60Hz setting in the United States. If the AC interference is present, check to see that the proper AC filter is selected.

Paper Speed

The writer speed can be configured at 25mm/s or 50mm/s for default ECG printouts. For rhythm printouts and display, speeds of 5mm/s or 10mm/s are also available. See the Assembly/Disassembly section to change speeds for display or rhythm printing.

Filter

The ECG plot frequency filter (or print filter) can be set to 40Hz, 150Hz, or 300Hz. The plot frequency filter does not filter the acquired digital record. A 40Hz plot filter setting will reduce the noise (40Hz and higher frequencies) on the printed ECG, a 150Hz plot filter setting will reduce the noise (150Hz and higher frequencies) on the printout and a 300Hz plot filter setting will not filter the printed ECG.

Height/Weight Units

This option defines the units of weight and height to either pounds/inches (lb/in) or kilograms/centimeters (kg/cm).

Date Format

This option defines the format for entering and displaying the patient's date of birth in either the U.S. format or the European format.

For example: **July 16th, 2003 is displayed as follows:**

US Date Format: **MM/DD/YYYY (07/16/2003)**

European Date Format: **DD.MM.YYYY (16.07.2003)**

NOTE: the date format option does not modify the acquisition date printed on each ECG. Using the example above, the acquisition date would print as 16-Jul-2003.

Plot Format

This option defines the default for one of five available plot formats in either Standard or Cabrera presentation. Please note that regardless of the plot format selected, 10 seconds of 12-leads are always stored.

The ECG plot options are:

Format Option	ECG Data
3+1	2.5 seconds of 12 leads in a three-channel format and the fourth channel is a 10 second rhythm strip of lead II (user defined).
6	5 seconds of 12-leads in a six-channel format
3+3	2.5 seconds of 12 leads in a three-channel format plus 10 second rhythm strip of leads II, V1 and V5 (user defined) in a three-channel format.
12	10 seconds of 12 leads in a 12 channel format
6+6	10 seconds of 12 leads in a 2 page printout (six channels per page)

Interpretation Option

The ELI 250 automatically analyzes ECGs and prints the optional interpretation on the ECG printout. This option allows you to select or suppress the “interpretive” text on the ECG report.

NOTE: A qualified physician should review the computer generated ECG interpretation before the treatment of any patient.

Reasons

The reason statements indicate why a particular interpretive statement was printed. Reasons statements print in [square brackets] within the interpretive text (if the interpretation is turned on). Turning the reason statement function on or off does not affect the measurements performed or the interpretive statements selected by the analysis program.

For Example:

Anteroseptal Infarct [40+ MS Q WAVE IN V1-V4] Where

“Anteroseptal Infarct” is the interpretive statement.

And “40+ MS Q WAVE IN V1-V4” is the reason statement or explanation as to why the interpretive statement was printed.

Configuration Page3

Modify Configuration Page 3/6		▲	F1
Append	UNCONFIRMED REPORT	▼	F2
# of Copies	0		F3
# ECGs Retrieved	4	▶	F4
Delete Rule	Post Transmit		F5
Storage Sensitivity	Normal	Page	F6
Auto - save ECG	Yes		
Auto - print ECG	Yes		
Baud rate	38400		
Use A4 paper	No		
Caps Lock	No	Exit	

Append

A status or statement phrase can be appended to the ECG and printed under the interpretive text printout. Either “unconfirmed report” or “reviewed by” can be selected. However, if you wish to have nothing appended to the ECG, “blank” may be selected.

Number of Copies

This option defines the number of printed copies when an ECG is taken. A zero (0) setting prints the original only; one (1) prints the original plus 1 copy; two (2) prints the original plus 2 copies, and so on. Up to 9 copies may be selected.

ECGs Retrieved

This option defines the number of ECGs retrieved from an E-Scribe data management system. The ECGs are retrieved by ID number. A zero (0) setting retrieves the most current ECG for that ID number. Settings from one

(1) to nine (9) retrieve the most current ECG plus “X” number of ECGs identified by the entered value.

EXAMPLE: If you enter the number 5, you will retrieve the most current ECG plus the five preceding ECGs for that ID number. ECGs retrieved from the E-Scribe are only printed at the ELI250 and not saved.

Delete Rule

This option defines the ECG auto delete status in the patient directory. ECGs that are marked for deletion will be automatically removed or erased based on their record size to make room necessary for the new ECG record. ECGs are only erased from the directory when they are marked for deletion and if the directory becomes full. The delete rule selections are:

Post Plot = ECG is automatically marked deleted after printing.

Post Transmit = ECG is automatically marked deleted after transmission.

Post Plot/Transmit = ECG is automatically marked deleted after transmission and printing.

Storage Sensitivity

The ECG storage sensitivity setting dictates the resolution of the stored record. The sensitivity settings are either Normal or High. If the configuration value is set to High, the stored ECG will have a high resolution. As a result, the records size will be large and will reduce the storage capacity in the ECG directory.

Auto Save ECG

This option defines whether or not the ELI 250 is to automatically save newly acquired ECGs in the directory, once they are acquired and printed. If the auto save configuration option is set to NO, and the record is printed, the ELI 250 will prompt you to “Save ECG?” **SAVE (F1)** will store the ECG in the directory.

NOTE: manually save ECGs by selecting More (F5) from the Acquired ECG view and Save (F5).

Auto Print ECG

This option defines whether or not the ELI 250 will automatically print the ECG after acquisition. If the selected configuration option is set to NO, a manual printout is possible after acquisition.

Baud Rate

The user-selectable baud rate determines the serial port's data transmission rate in bits per second (bps). Set the baud rate to: 9600, 19200, 38400, 57600, or 115200 bps for direct data transmission between the ELI 250 and another Welch Allyn cardiograph, and 38400 bps for a direct connection to the E-SCRIBE data management system.

Use A4 Paper

The ELI 250 accommodates use of Z-fold thermal paper in either the letter size (8.5 x 11 inches; 216 x 279 mm) or the “A4” size (8.27 x 11.69 inches; 210 x 297 mm). The provided paper tray spacer is required for use with A4 size paper. Enable this configuration option for A4 printing. The paper tray spacer should not be inserted if the letter size paper is used.

Caps Lock

All character entry is translated to upper case.

Configuration Page 4

Modify Configuration Page 4/6		▲	F1
Rhythm Format	3 Channel	▼	F2
3 Rhythm Lead 1	II	▶	F3
3 Rhythm Lead 2	V1	Page	F4
3 Rhythm Lead 3	V5		F5
6 Rhythm Lead 1	V1	Exit	F6
6 Rhythm Lead 2	V2		
6 Rhythm Lead 3	V3		
6 Rhythm Lead 4	V4		
6 Rhythm Lead 5	V5		
6 Rhythm Lead 6	V6		

Rhythm Formats

Configuration page four defines the default values for rhythm printing. It is possible to set a 3-channel, 6-channel or 12-channel default rhythm format. Define rhythm leads one through three to customize a three-channel rhythm

printout or define rhythm leads one through six to customize the six-channel rhythm printout. Use (F3) to toggle through each of the 12 leads.

Configuration Page5

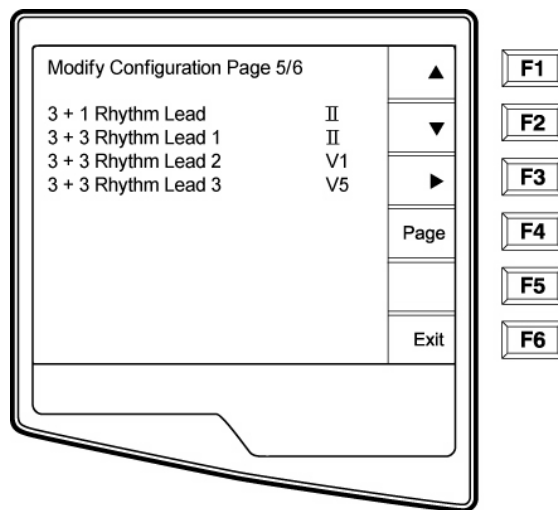

Rhythm Leads

Configuration page five identifies the user-selectable 10-second rhythm lead printed in a 3 + 1 channel ECG printout and the three 10-second rhythm leads for the 3+3 channel ECG printout. Use (F3) to make your selection of any of the 12 leads.

NOTE: rhythm acquisition is not stored in memory, only printed. NOTE: see the Assembly/Disassembly section to acquire a rhythm printout.

Configuration Page 6 (optional LAN connectivity)

The ELI 250 connectivity options are RS232 (or direct), modem, LAN or WLAN. Configuration parameters Associated with each type of transmission media will be presented in configuration pages six and seven only if those media are installed in the cardiograph.

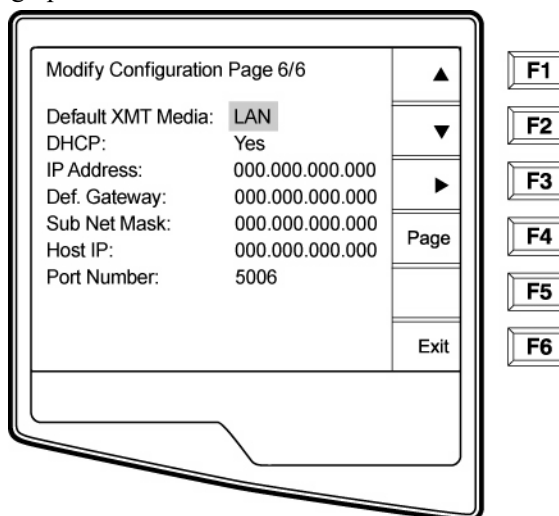

Default XMT Media

Configuration page 6 identifies the default transmission media. Those connectivity options which have been optionally purchased and installed (RS232, modem, LAN or WLAN) in your ELI 250 will be available for default selection.

DHCP

This setting defines whether the Dynamic Host Communication Protocol(DHCP) will be used to obtain an IP address. IfDHCP is Yes, the network will automatically and dynamically assign an IP address therefore, there is no need to manually enter an IP address. If DHCP is No, you must enter the IP address, Def Gateway and Sub Net Mask.

NOTE: all parameters related to network connection must be entered under the direction of the IT Manager of the facility where the unit is installed.

IP Address

Define the fixed IP address used by the ELI 250 for network transmission (if DHCP is not selected).

Def Gateway

Enter the address of the default gateway (if DHCP is not selected).

Sub Net M ask

Enter the Sub Net address (if DHCP is not selected).

Host IP

Enter the IP address of the host server.

Note: addresses are always entered as 4 sets of 3 digits; therefore, an address of 192.168.0.7 must be entered on the ELI 250 as 192.168.000.007.

Port Number

Enter the port number used by the host server.

Configuration Page 6, continued (optional WLAN connectivity)

Modify Configuration Page 6/7		▲	F1
Default XMT Media:	WLAN	▼	F2
DHCP:	No	▶	F3
IP Address:	000.000.000.000	Page	F4
Def. Gateway:	000.000.000.000		F5
Sub Net Mask:	000.000.000.000	Exit	F6
Host IP:	000.000.000.000		
Port Number:	0		
SSID:			
No SSID:			
Channel Number	6		

SSID

Service Set Provider (SSID) is the name of the wireless network. All ELI 250 electrocardiographs that will transmit to the same network must have the same SSID name. This field is case sensitive.

Channel Number

This defines the channel used by the radio to search for the network. The exact channel number varies according to which type of wireless network is used and the country in which you install the WLAN. When moving from one area to another, the ELI250 WLAN card will automatically scan for the channel of the closest access point.

Configuration Page 7(optional WLAN connectivity, continued)

The screenshot shows a configuration screen titled "Modify Configuration Page 7/7". The screen displays the following settings:

- Security (WEP): No
- WEP Key: 0
- WEP Key ID: 00-00-00-00-00-00
00-00-00-00-00-00-00

On the right side of the screen, there are several navigation buttons: an up arrow, a down arrow, a right arrow, a "Page" button, and an "Exit" button. To the right of the screen, there are six function key icons labeled F1 through F6.

Security (WEP)

Wired Equivalent Privacy (WEP) is an encrypted security protocol, part of the 802.11 standard, and is used to protect the network from unauthorized users. The IT Manager will provide the 26 HEX digits that are the same to be used by all access points on the network. Therefore, only devices with the proper WEP will be able to login. The ELI 250 adopts a 128-bit encryption. Access points can have multiple WEP Keys stored. Each one of them is identified by a number (e.g., 0, 1, 2, 3).

WEP Key

Enter the WEP Key number (e.g., 0, 1, 2, 3).

WEP Key ID

Enter the 128-bit WEP Key ID value (26 digits in 13 sets of two digits).

Access Configuration Menus for the ELI 210

Three configuration pages define all ELI 210 operational conditions that do not change on a daily or patient-to-patient basis. Once you set these default conditions, you will rarely need to use the configuration screens again. When you apply power to the ELI 210, it will operate according to the settings you have selected. To access the configuration menus:

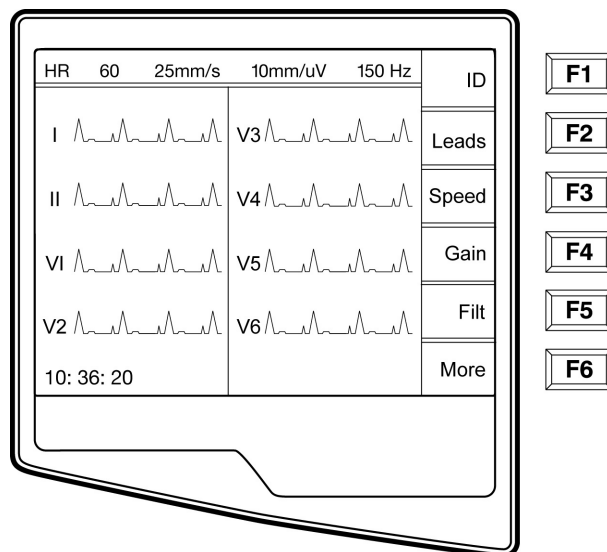

- ☐ Select **More (F6)** from the Real-Time ECG View.

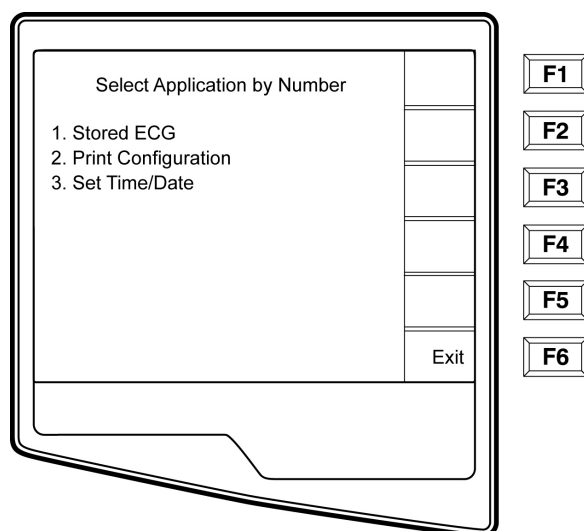

Select **Set Time/Date** (number 3) from the application menu.

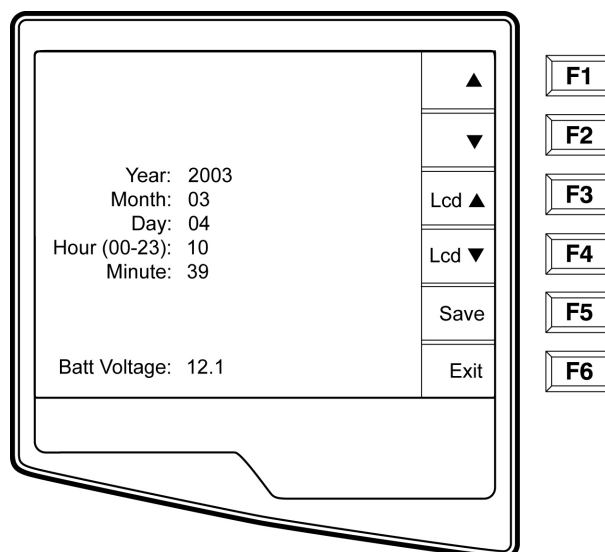

- ☒ Simultaneously press ▲ (F1) and ▼ (F2). The first configuration screen will appear. There are a total of 3 configuration screens. Notice the page indicator in the upper right-hand corner on each screen.

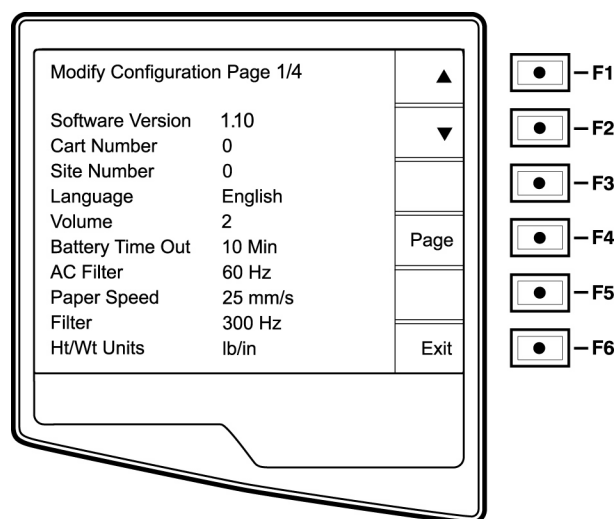

- NOTES:**
- Use **Page (F4)** to toggle through the three configuration pages.
 - Use ▲ (F1) and ▼ (F2) to move back and forth through each configuration option.
 - Use ► (F3) to toggle through pre-programmed available settings per configuration field.
 - Use **Exit (F6)** to return to the Real-Time ECG View. Any changes you have made will be saved.

The following chart summarizes the configuration screens and the available options for each parameter.

Summary of Configuration Menus

Configuration Parameter	Definition	Configuration Screen
Software Version	The firmware version of the unit	Screen One
Cart Number	User-defined (4 digits)	Screen One
Site Number	User-defined (4 digits)	Screen One
Language	Firmware language availability	Screen One
Volume	Range from 0 – 8	Screen One
Battery Timeout	10min, 30min, 60min	Screen One
AC Filter	None, 60Hz, 50Hz	Screen One
Paper Speed	25mm/sec or 50 mm/sec	Screen One
Filter	40Hz, 150Hz, or 300Hz	Screen One
Height/Weight Units	lb/in or kg/cm	Screen One
Date Format	US (mm/dd/yyyy) or European (dd.mm.yyyy)	Screen Two
Plot Format	Channels printed: 3+1, 6, 3+3, 12, 6+6, Cabrera or Standard	Screen Two
Interpretation	Yes or No	Screen Two
Reasons	Yes or No	Screen Two
Append to ECG	Unconfirmed, Reviewed by, Blank	Screen Two
# Copies	0 - 9	Screen Two
Use A4 paper	Yes or No	Screen Two

Configuration Parameter	Definition	Configuration Screen
Rhythm format	3 channel, 6 channel or 12 channel	Screen Three
3 Rhythm Lead 1	V1-V6, I, II, III, aVR, aVL, aVF	Screen Three
3 Rhythm Lead 2	V1-V6, I, II, III, aVR, aVL, aVF	Screen Three
3 Rhythm Lead 3	V1-V6, I, II, III, aVR, aVL, aVF	Screen Three
6 Rhythm Lead 1	V1-V6, I, II, III, aVR, aVL, aVF	Screen Three
6 Rhythm Lead 2	V1-V6, I, II, III, aVR, aVL, aVF	Screen Three
6 Rhythm Lead 3	V1-V6, I, II, III, aVR, aVL, aVF	Screen Three
6 Rhythm Lead 4	V1-V6, I, II, III, aVR, aVL, aVF	Screen Three
6 Rhythm Lead 5	V1-V6, I, II, III, aVR, aVL, aVF	Screen Three
6 Rhythm Lead 6	V1-V6, I, II, III, aVR, aVL, aVF	Screen Three
3 + 1 Rhythm Lead	V1-V6, I, II, III, aVR, aVL, aVF	Screen Four
3 + 3 Rhythm Lead 1	V1-V6, I, II, III, aVR, aVL, aVF	Screen Four
3 + 3 Rhythm Lead 2	V1-V6, I, II, III, aVR, aVL, aVF	Screen Four
3 + 3 Rhythm Lead 3	V1-V6, I, II, III, aVR, aVL, aVF	Screen Four

Configuration Page1

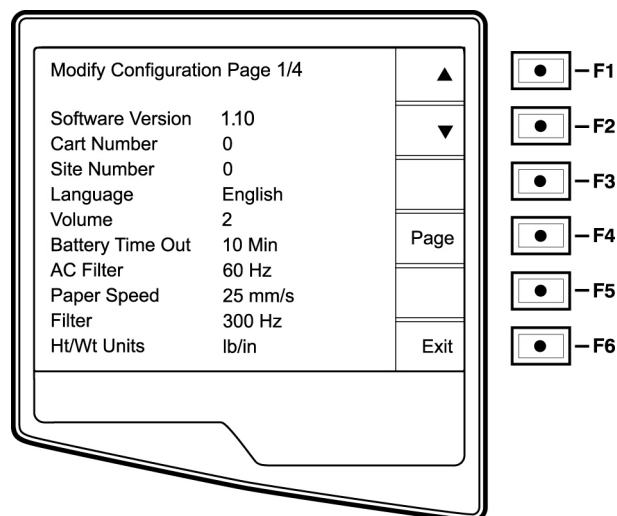

Software Version

The displayed number identifies the firmware version of your electrocardiograph.

Cart Number

Cart numbers indicate which electrocardiograph transmitted a particular ECG. You can use up to four digits for the cart number.

Site Number

This option identifies the site of your ELI 210. You can use up to four digits for the site number.

Language

There are several languages available on the cardiograph.

CAUTION: upon selecting a new language and exiting the configuration screen, function labels are immediately translated.

If an unknown language is visible, use the following steps to revert to the language of your country:

7. **F6** from Real-Time ECG View
8. Select number **3**
9. Simultaneously press **▲ (F1)** and **▼ (F2)**.
10. Press **F2 (▼)** two times
11. Press **F3 (▶)** until the desired language appears
12. **F6** to return to Real-Time ECG View

Volume

This option defines the keyboard click loudness. Available settings range from 0 (off) to 8 (loud).

Battery Timeout

This setting determines when the cardiograph will switch off in order to conserve the battery life of the unit. The battery timeout will only occur if the keypad has not been depressed for the time specified. This setting will be ignored while the unit is transmitting, rhythm printing or detects an ECG input signal.

AC Filter

The ELI 210 removes 60Hz or 50Hz interference. The setting you select depends on the line frequency in your country. Always use the 60Hz setting in the United States. If the AC interference is present, check to see that the proper AC filter is selected.

Paper Speed

The writer speed can be configured at 25mm/s or 50mm/s for default ECG printouts. For rhythm printouts and display, speeds of 5mm/s or 10mm/s are also available. See the Assembly/Disassembly section to change speeds for display or rhythm printing.

Filter

The ECG plot frequency filter (or print filter) can be set to 40Hz, 150Hz, or 300Hz. The plot frequency filter does not filter the acquired digital record. A 40Hz plot filter setting will reduce the noise (40Hz and higher frequencies) on the printed ECG, a 150Hz plot filter setting will reduce the noise (150Hz and higher frequencies) on the printout and a 300Hz plot filter setting will not filter the printed ECG.

Height/Weight Units

This option defines the units of weight and height to either pounds/inches (lb/in) or kilograms/centimeters (kg/cm).

Configuration Page2

Modify Configuration Page 2/4

Date Format	MM/DD/YYYY
Plot Format	3+1 Channel
Interp	No
Reasons	Yes
Append	UNCONFIRMED REPORT
# Copies	0
Use A4 Paper	No

— F1
— F2
— F3
— F4
— F5
— F6

Date Format

This option defines the format for entering and displaying the patient's date of birth in either the U.S. format or the European format.

For example: July 16th, 2003 is displayed as follows:

US Date Format: MM/DD/YYYY (07/16/2003)
European Date Format: DD.MM.YYYY (16.07.2003)

NOTE: the date format option does not modify the acquisition date printed on each ECG. Using the example above, the acquisition date would print as 16-Jul-2003.

Plot Format

This option defines the default for one of five available plot formats in either Standard or Cabrera presentation. Please note that regardless of the plot format selected, 10 seconds of 12-leads are always stored and printed. The ECG plot options are:

Format Option	ECG Data
3+1	2.5 seconds of 12 leads in a three-channel format and the fourth channel is a 10 second rhythm strip of lead II (user defined).
6	5 seconds of 12-leads in a six-channel format
3+3	2.5 seconds of 12 leads in a three-channel format plus 10 second rhythm strip of leads II, V1 and V5 (user defined) in a three-channel format.

12	10 seconds of 12 leads in a 12 channel format
6+6	10 seconds of 12 leads in a 2 page printout (six channels per page)

Interpretation Option

The ELI 210 automatically analyzes ECGs and prints the optional interpretation on the ECG printout. This option allows you to select or suppress the “interpretive” text on the ECG report.

NOTE: A qualified physician should review the computer generated ECG interpretation before the treatment of any patient.

Reasons

The reason statements indicate why a particular interpretive statement was printed. Reason statements print in [square brackets] within the interpretive text (if the interpretation is turned on). Turning the reason statement function on or off does not affect the measurements performed or the interpretive statements selected by the analysis program. See Appendix B for examples of the ECG reason statements on the sample printouts.

For Example:

Anteroseptal Infarct [40+ MS Q WAVE IN V1-V4]

Where “Anteroseptal Infarct” is the interpretive statement.

And “40+ MS Q WAVE IN V1-V4” is the reason statement or explanation as to why the interpretive statement was printed.

Append to ECG

A status or statement phrase can be appended to the ECG and printed under the interpretive text printout. Either “unconfirmed” or “reviewed by” can be selected. However, if you wish to have nothing appended to the ECG, blank may be selected.

Number of Copies

This option defines the number of printed copies when an ECG is taken. A zero (0) setting prints the original only; one (1) prints the original plus 1 copy; two (2) prints the original plus 2 copies, and so on. Up to 9 copies may be selected.

Use A4 Paper

The ELI 210 accommodates use of Z-fold thermal paper in either the letter size (8.5 x 11 inches; 216 x 279 mm) or the “A4” size (8.27 x 11.69 inches; 210 x 297 mm). The provided paper tray spacer is required for use with A4 size paper. Enable this configuration option and printing on A4 paper is possible. The paper tray spacer should not be inserted if the letter size paper is used.

NOTE: Paper tray spacer must be inserted for use with A4 size paper.

Configuration Page3

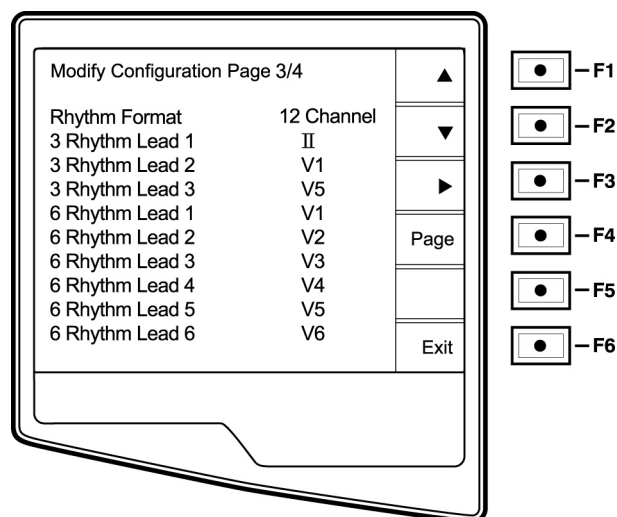

Rhythm Formats

Configuration page four defines the default values for rhythm printing. It is possible to set a 3-channel, 6-channel or 12-channel default rhythm format. Define rhythm leads one through three to customize a three-channel rhythm

printout or define rhythm leads one through six to customize the six-channel rhythm printout. Use (F3) to toggle through each of the 12 leads.

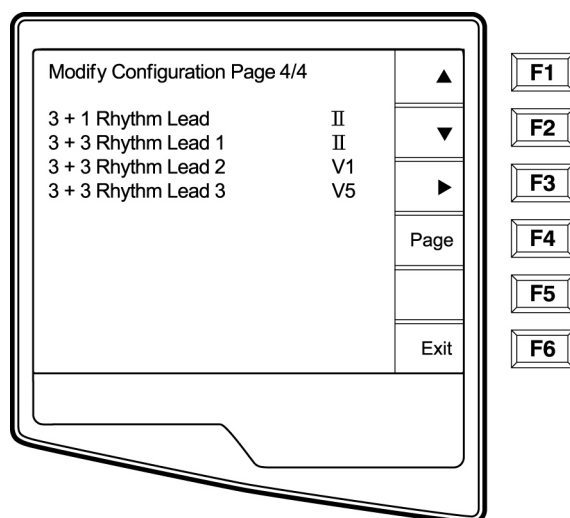

Rhythm Leads

Configuration page five identifies the user-selectable 10-second rhythm lead printed in a 3 + 1 channel ECG printout and the three 10-second rhythm leads for the 3+3 channel ECG printout. Use (F3) to make your selection of any of the 12 leads.

NOTE: rhythm acquisition is not stored in memory, only printed

ASSEMBLY/DISASSEMBLY OF UNIT



CAUTION:

Remove AC power and battery fuse before attempting any disassembly.

Removal of the battery fuse will not cause a loss of ECG's or of the configuration. This information is stored in FLASH memory.

For illustration purposes the ELI250 will be used to demonstrate the disassembly of the unit. The disassembly of the ELI 210 is identical except for the keyboard components. The parts list located on pages 5-6 and 5-7 of this manual.

Fuse Removal

Locate the fuse on the bottom of the unit.

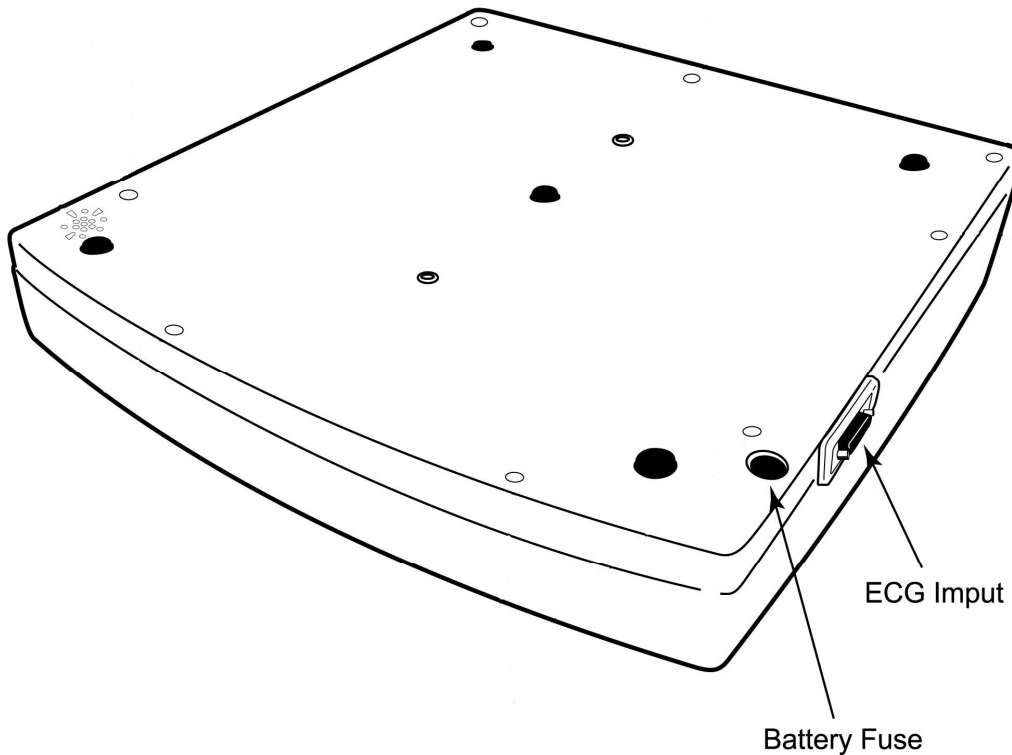

Insert a flat blade screwdriver into the slot of the fuse holder, push in slightly and rotate the screwdriver counterclockwise 1/4 turn. The fuse holder is spring loaded and will come out easily.

Cover Assembly Removal / Installation

From the standard operating position:

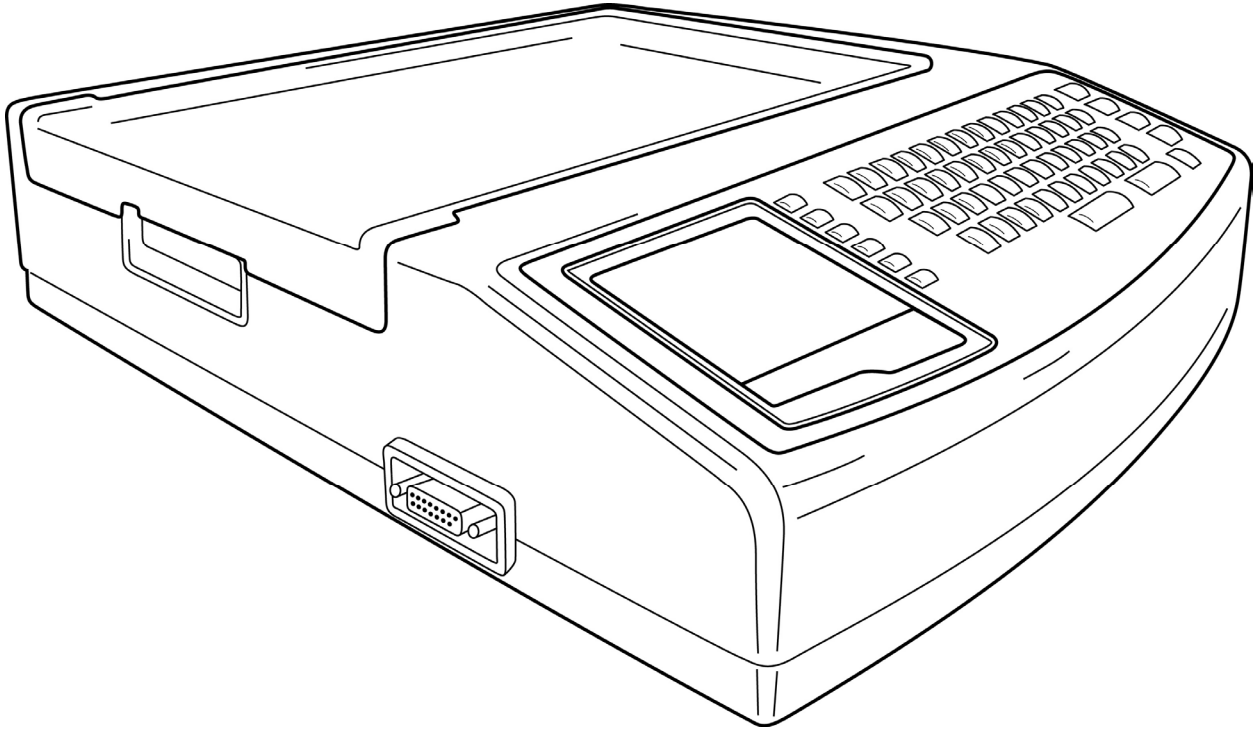

Picture shown is ELI 250

Flip unit over so that it is resting on the writer. Locate the mounting screws for the top cover. These are the screws around the perimeter of the unit and marked with arrows in the plastic.

Loosen these screws, item number 14 in parts list, using a Philips head screwdriver.

Note: When removing screws, loosen the screw and do not remove, the screw can remain in the screw hole by placing tape over the holes with the screw still in the hole. The tape will hold the screw so that it will not be lost during disassembly.

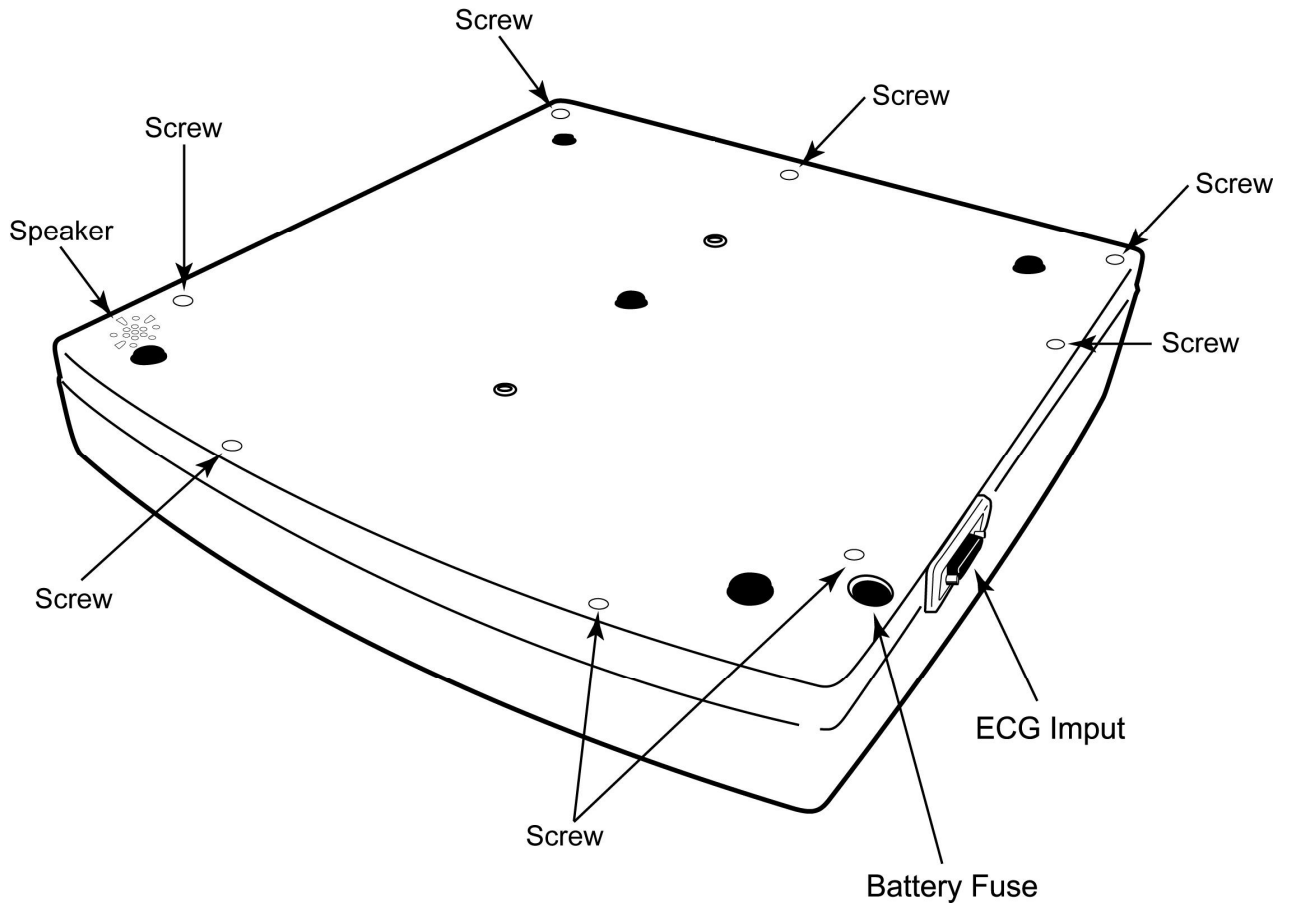

Flip the unit upright so that it is in its normal position.



CAUTION

The unit will be in three pieces, the Top, the Bottom and the Connector Bulkhead. Care must be taken when flipping the unit over. Hold the top cover to the bottom of the unit securely when flipping unit over.

Open the writer door approximately 4 to 5 inches.

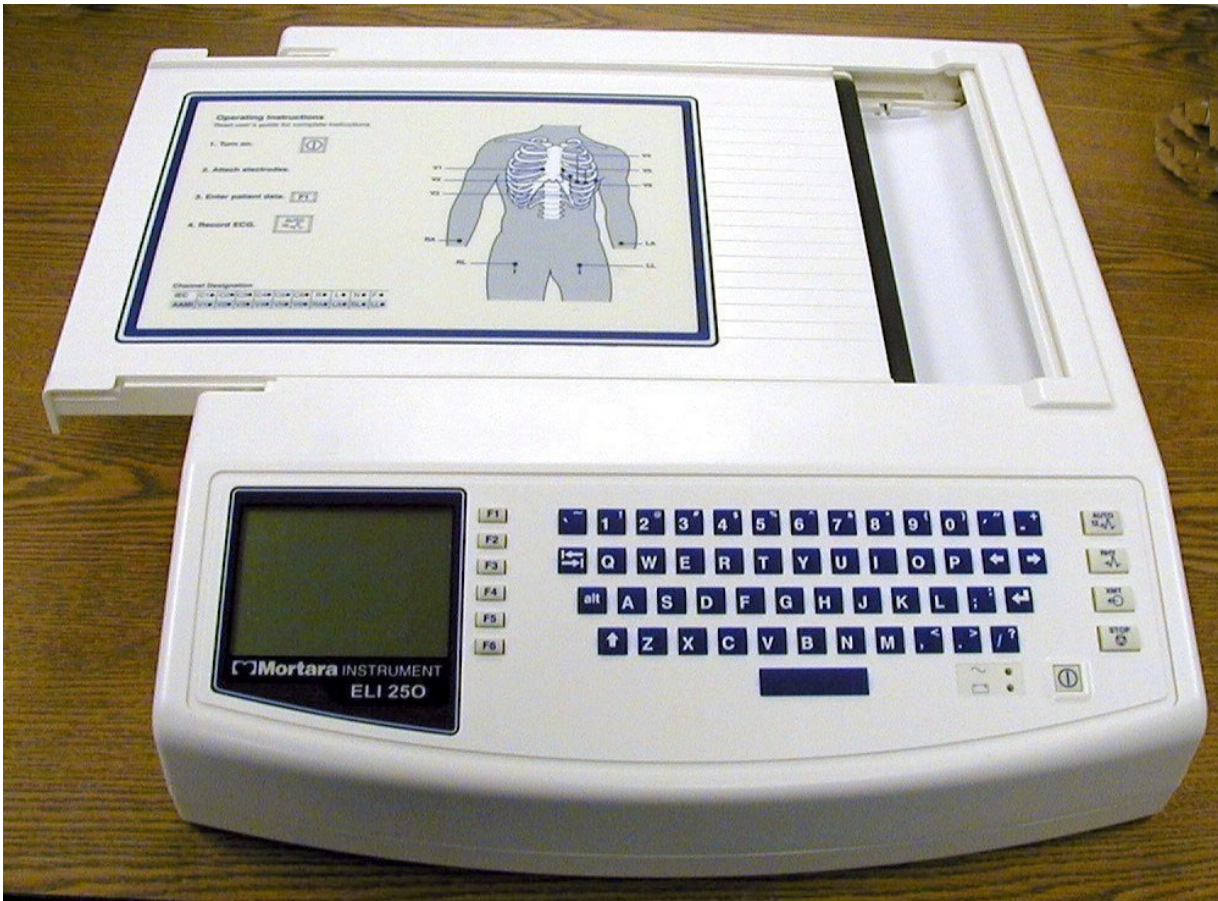

Lift up and rotate the right side of the top cover to left a small distance. Rest the cover on the top of the writer this will allow you to remove the Keyboard/LCD cable, item number 34, from the motherboard.

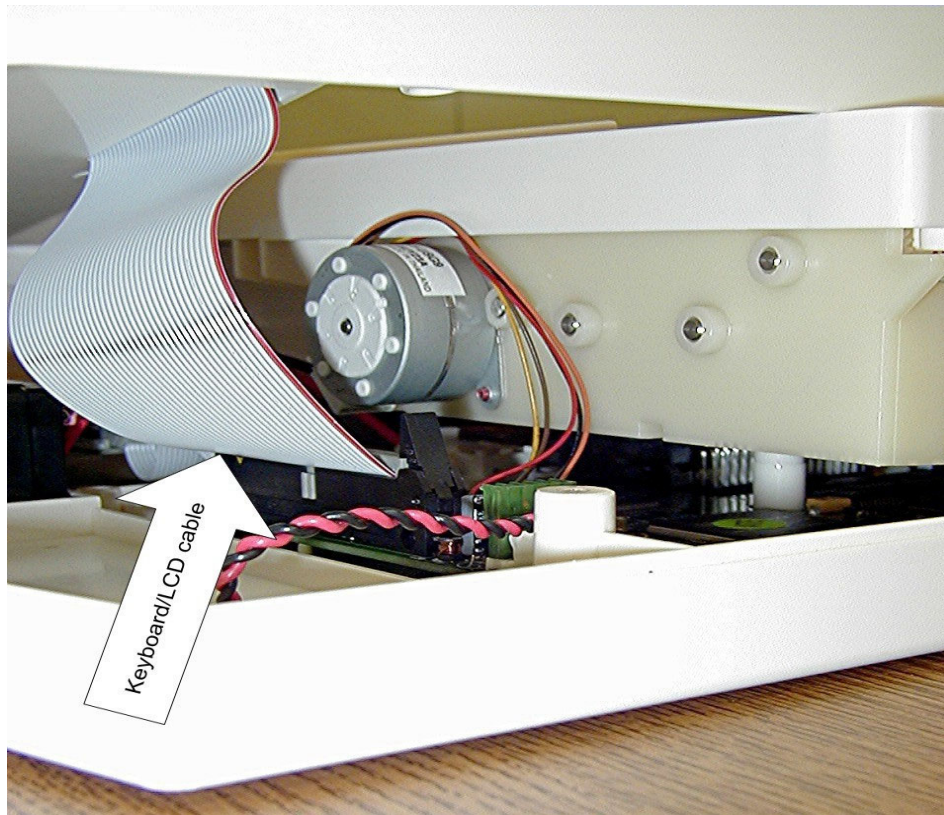

Note: Slide your hand into the unit and disconnect the Keyboard/LCD, item 34, ribbon cable from the motherboard. This cable may be inserted into a quick-disconnect connector. Flip the latches of the connector and the cable will release. Not all motherboards will have the latches to secure the keyboard cable.

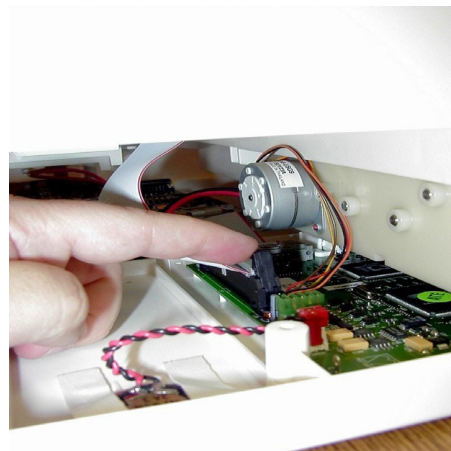
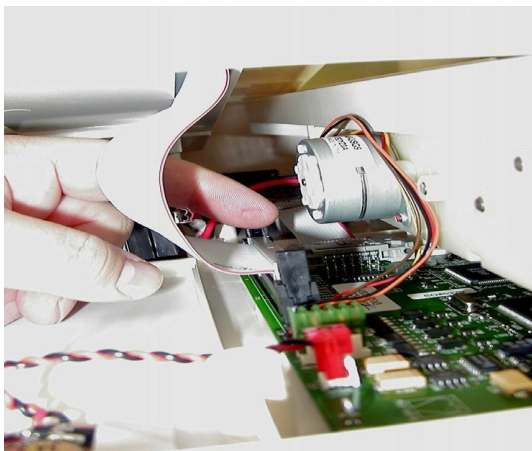

Slide top cover off the unit, rotating as needed to clear the writer door.

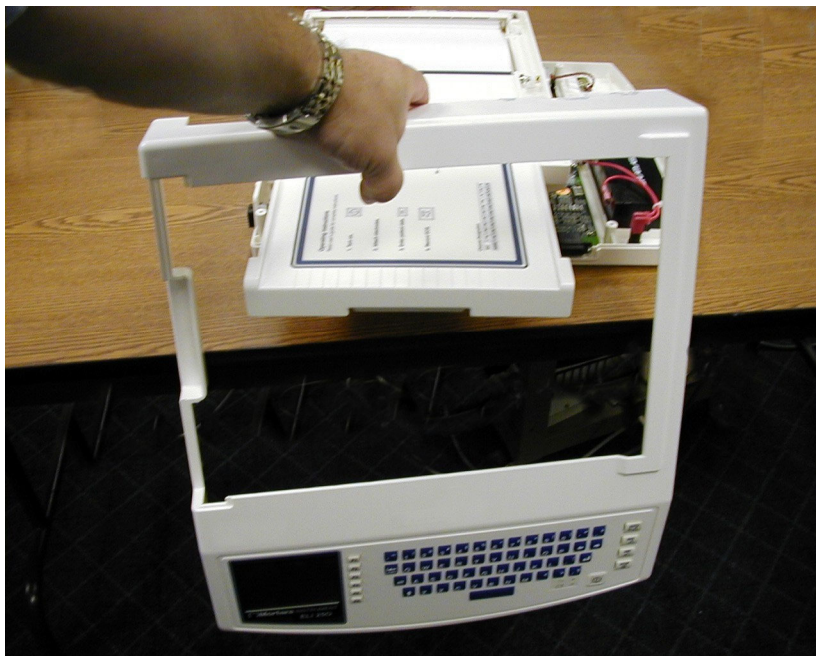

Set the cover to the side.

Re-assemble in reverse order.

Battery Removal

Once the top cover is removed, the battery can be accessed for replacement if needed. Make sure that the battery fuse has been removed.

Locate the battery, item number 11, near the front of the unit.

Slide the cable connections off of the battery.

The battery is attached to the unit using double-sided tape, using a flat blade screwdriver gently pry the battery loose from the bottom plastic chassis.

Install the new battery in the same location using double sided tape, item number 49, and reconnect the battery cables.

Replace the cover and install the battery fuse.

Keyboard/LCD Removal

With the top cover removed flip the cover over to access the inside of the top cover and locate the mounting screws for the keyboard and LCD.

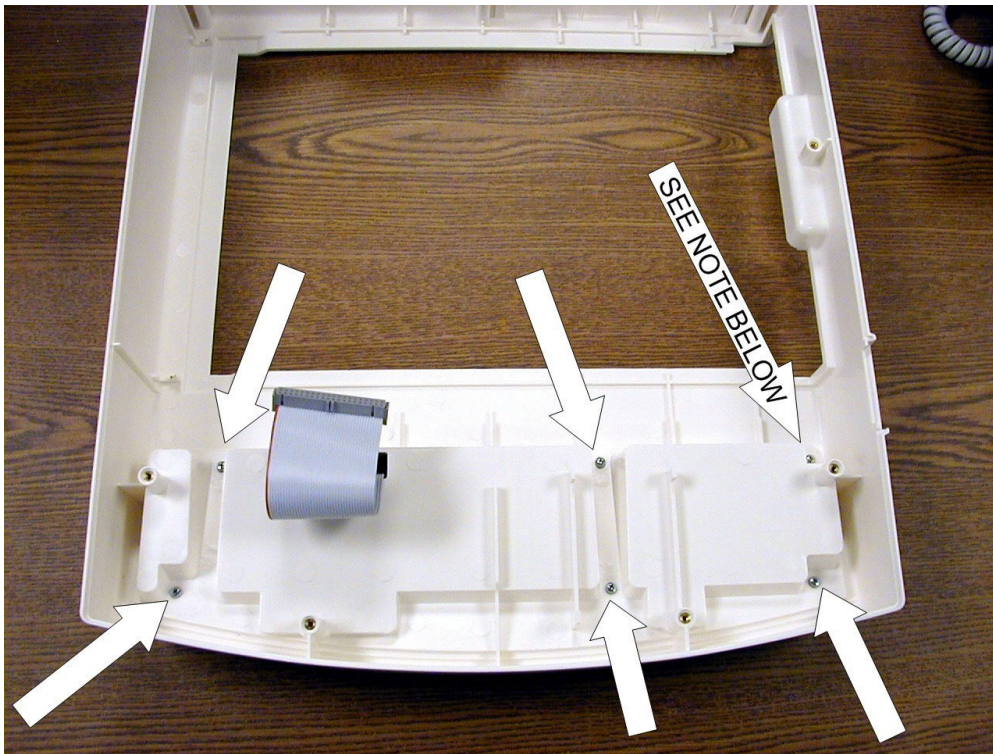

Note: 5 of the mounting screws are item number 13. The remaining screw, at the noted location is item 44 and is shorter than the other screws. This becomes important when reinstalling the keyboard assembly.

Remove the mounting screws from the underside of the cover.

The keyboard assembly can then be removed from the top cover. The picture below shows the keyboard assembly removed from the top cover and the Keyboard/LCD cable, item 34, removed.

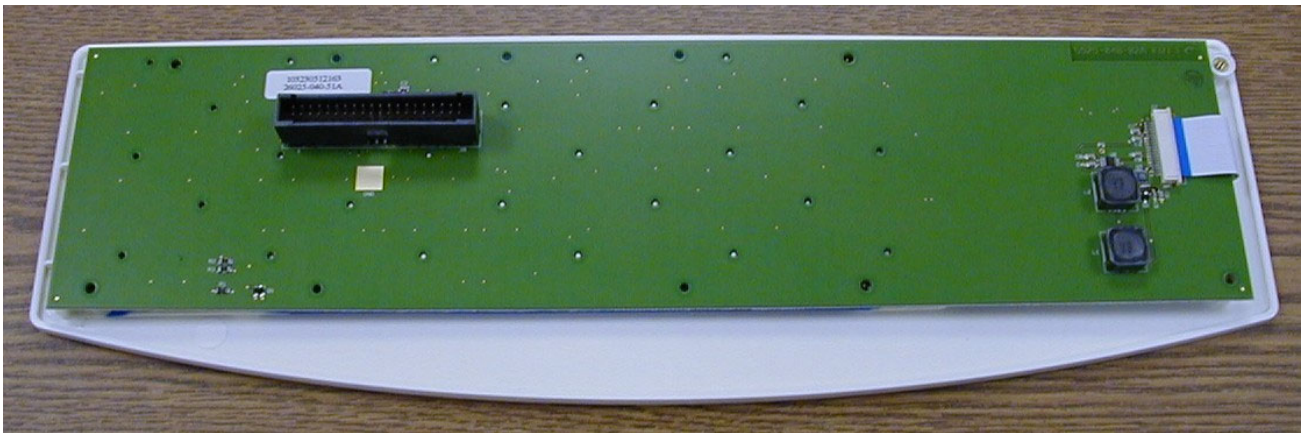

Remove the LCD cable from the keyboard by 1) sliding the connector to the right then 2) lifting up on the connector.

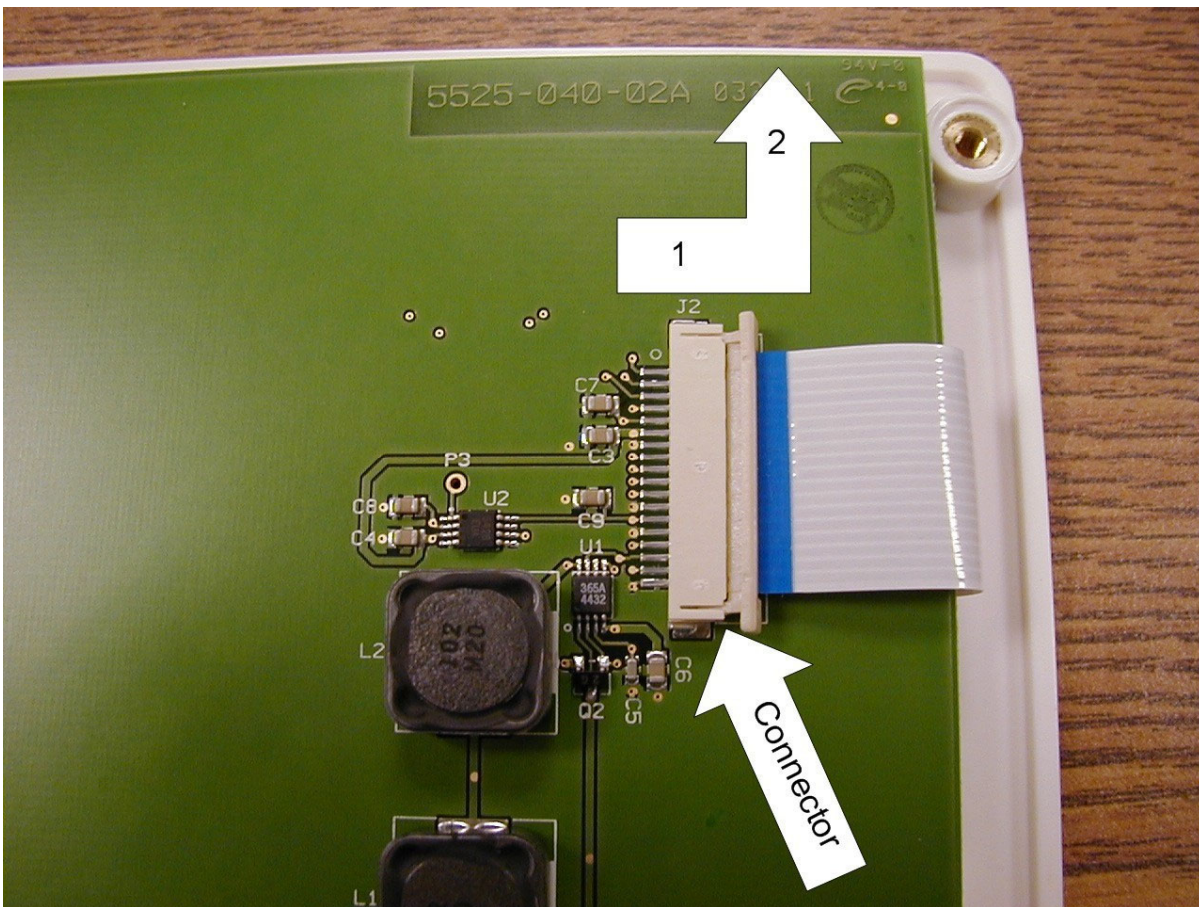

The keyboard circuit board, item number 3 for the ELI 250 and item number 4 for the ELI 210, can then be lifted off the assembly.

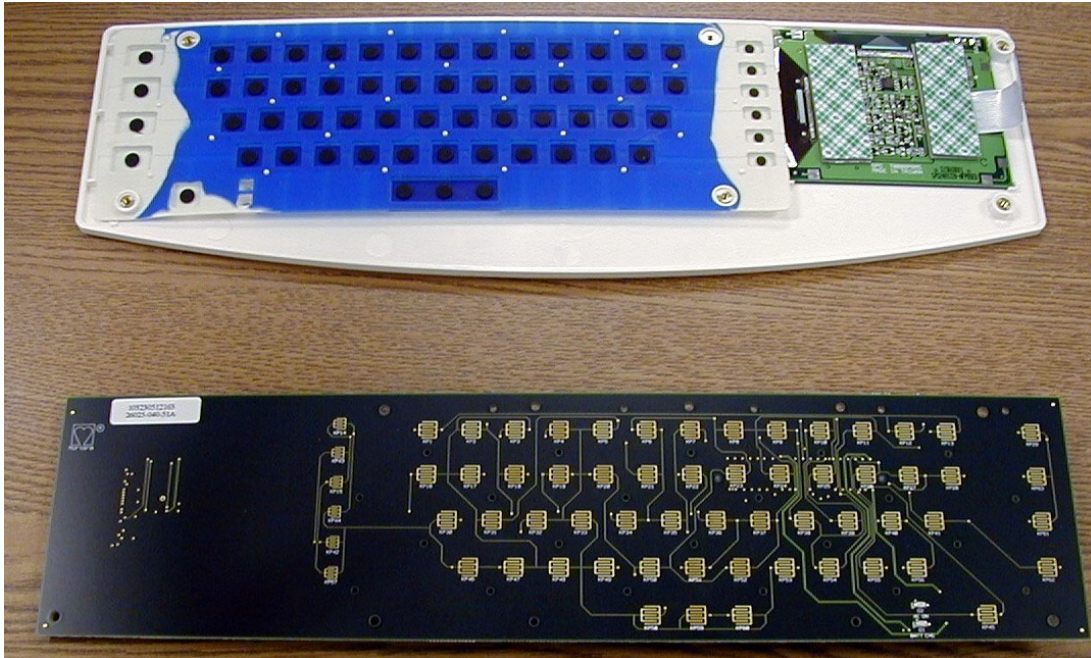

The silicon key pad, item 9 for the ELI 250 and item 10 for the ELI 210, can now be removed from the keyboard bezel, item 22 for the ELI 250 and item 23 for the ELI 210, along with the LCD.

The LCD is attached to the keyboard bezel by means of double-sided tape, item number 50, near the top of the LCD. Care should be taken when removing the LCD from the bezel.

When replacing the LCD, remove the old double-sided tape and cut a piece of double-sided tape approximately 3 inches. Place this strip of double-sided tape, item number 50, onto mounting surface on Keyboard Bezel as shown.

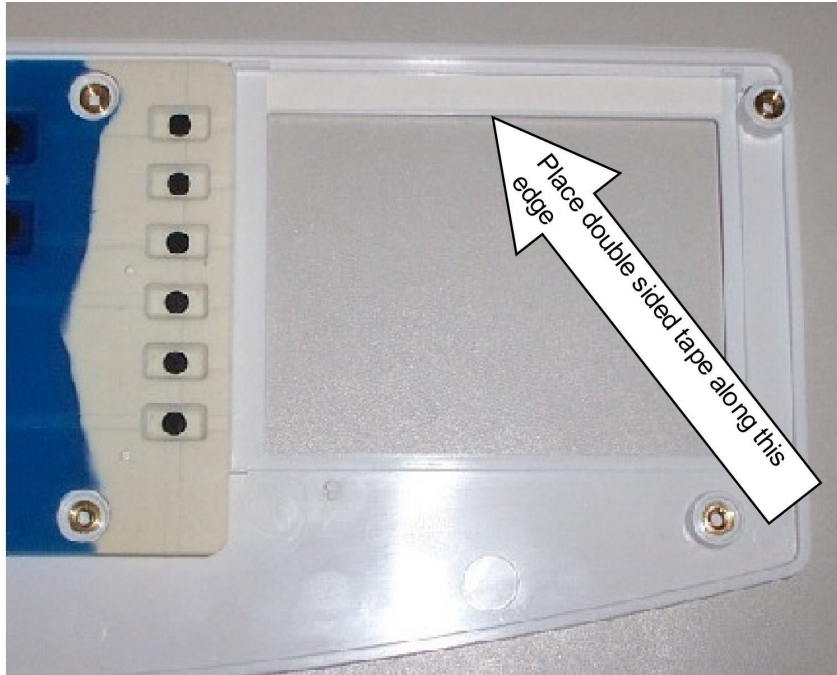

For the installation of a new LCD, item number 12, cut four pieces of foam tape, item number 51, to approximately 2 inches. Place two strips of foam tape onto LCD as shown. Place the remaining two strips over the first two strips as shown. Leave the paper backing on the foam tape

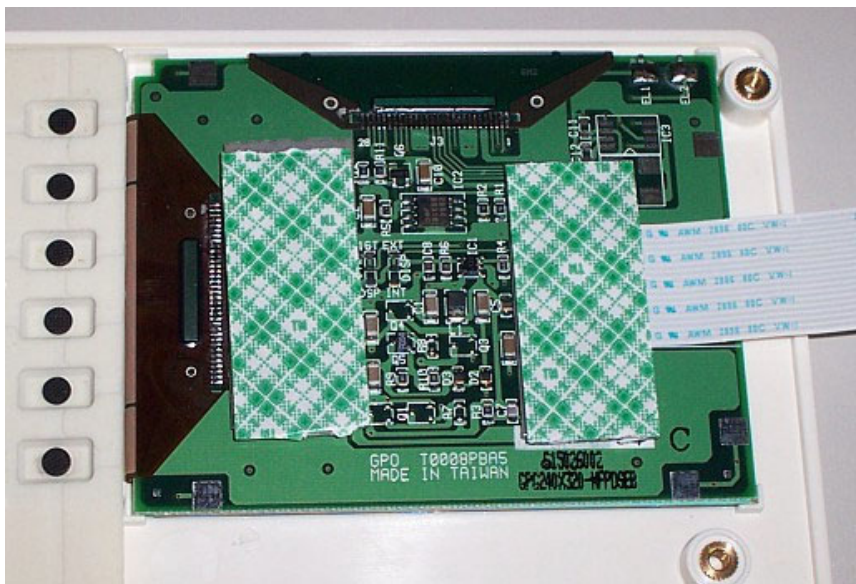

Reinstall Keyboard and LCD assembly in reverse order.

Writer Removal / Installation

Located on the perimeter of the motherboard are the cables for the writer. There are a total of 5 cables that need to be removed, 2 print head cables, 1 cue sensor cable, 1 print head ground cable and the writer motor cable.

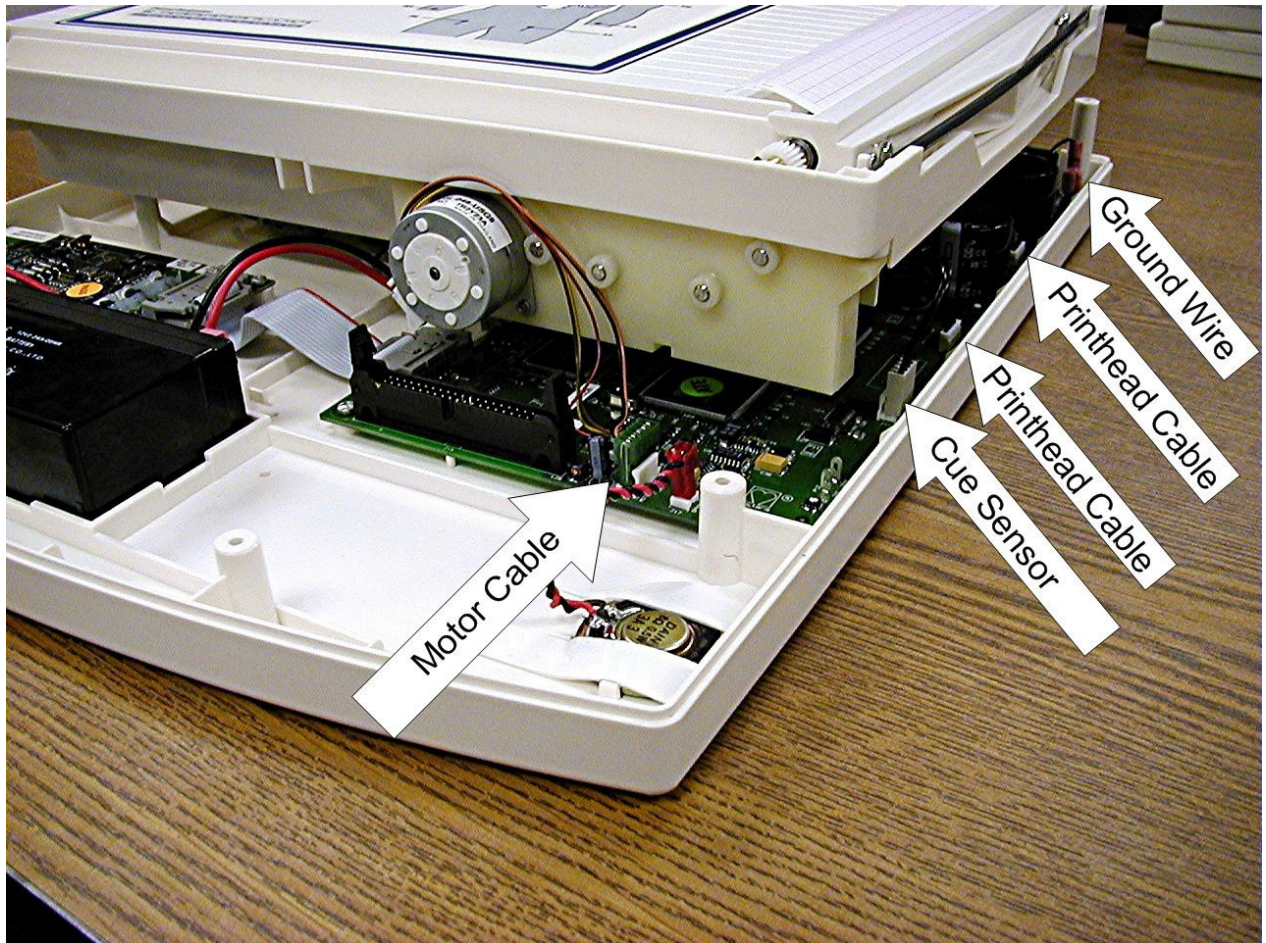

Remove the listed cables.

Flip the unit over and remove the 4 screws, item14, holding the writer to the bottom chassis.

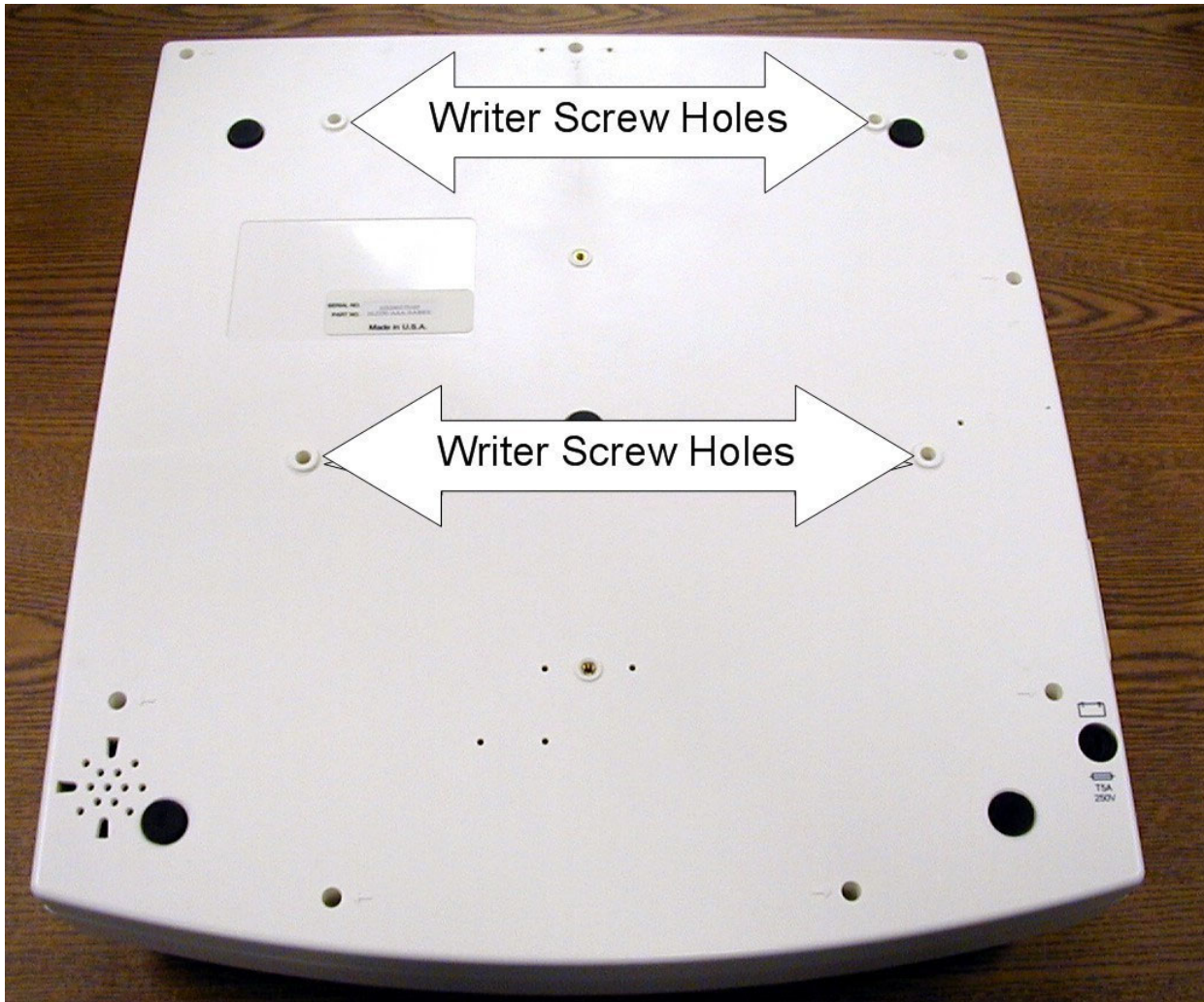

CAUTION



Due to the weight of the battery, the bottom chassis of the unit may tilt off the writer while the unit is upside down. Make sure that the bottom chassis is supported while performing this procedure.

Lift the bottom chassis straight off of the writer assembly. Re-assemble in reverse order.

Printhead Removal / Installation



CAUTION

The printhead is a static sensitive part. Proper measures should be taken when handling this part.

Note: The writer does not need to be removed from the unit for printhead to be replaced however removal of the writer from the chassis will make the job easier.

With the top cover of the unit removed, close the writer door and remove the printhead cables from the motherboard. See section on removing the cover.

Locate the O-Ring, on the underside of the printhead assembly, that secures the printhead assembly to the writer chassis and remove.



CAUTION

When the printhead spring bar is removed the printhead assembly will be loose. Care should be taken if this procedure is being performed with the writer assembly out of the unit and the writer assembly is upside down.

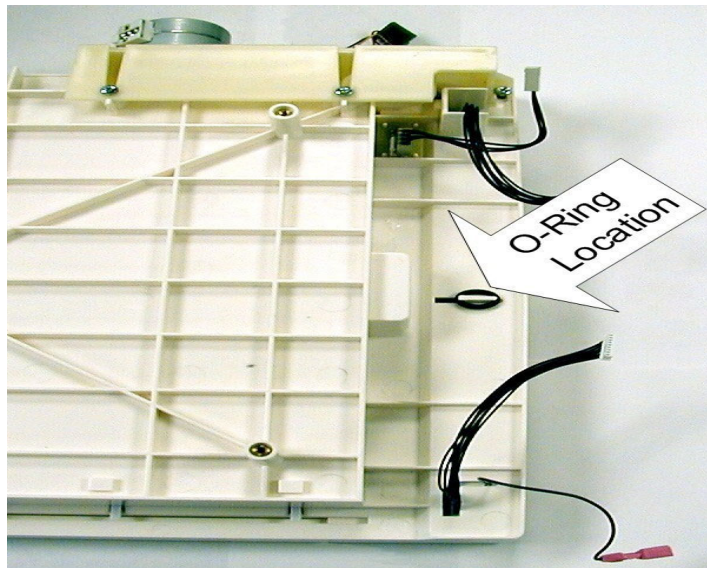

View from bottom of writer

assembly Open the writer door and remove the printhead spring bar.

Carefully guide the printhead assembly out of the writer chassis making sure that no damage occurs to the cables attached to the printhead.

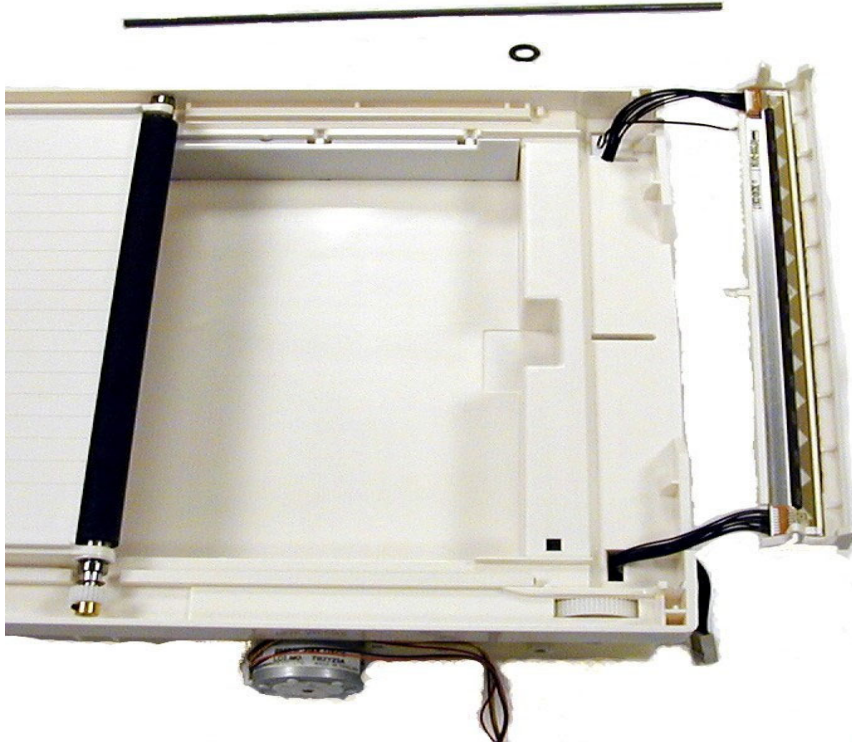

Remove the 4 screws, itemnumber52, that attach the printhead to the Printhead plastic support.

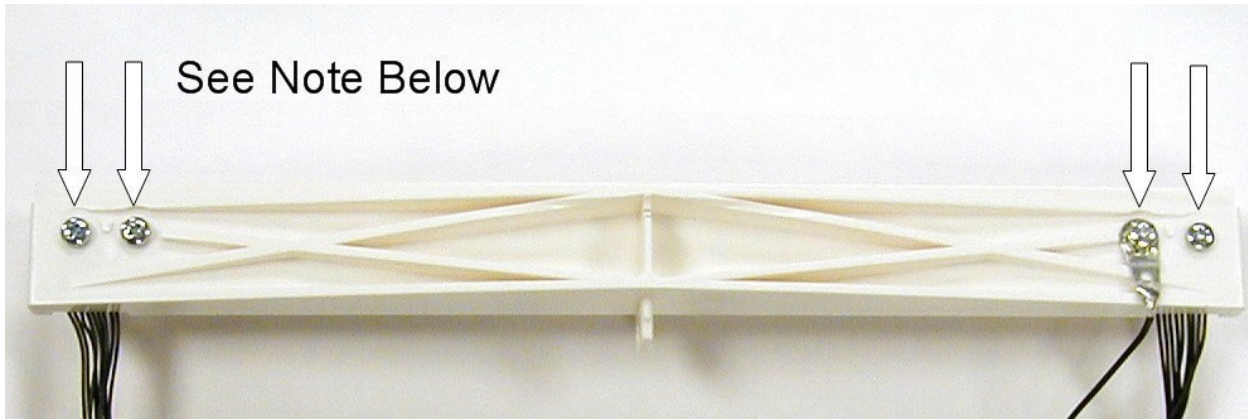

Note: These screws are coated with Vibratite They are then installed tight and backed off one quarter turn to allow for expansion and contraction between the printhead and the plastic housing.

Remove the cables attached to the printhead. Please note that on early units the cables are secured to the print head with adhesive. If the printhead or the cables require replacing the complete assembly should be replaced.

Re-assemble in reverse order.

Writer Motor Removal / Installation

Flip the writer assembly over and locate the writer motor and gear assembly.

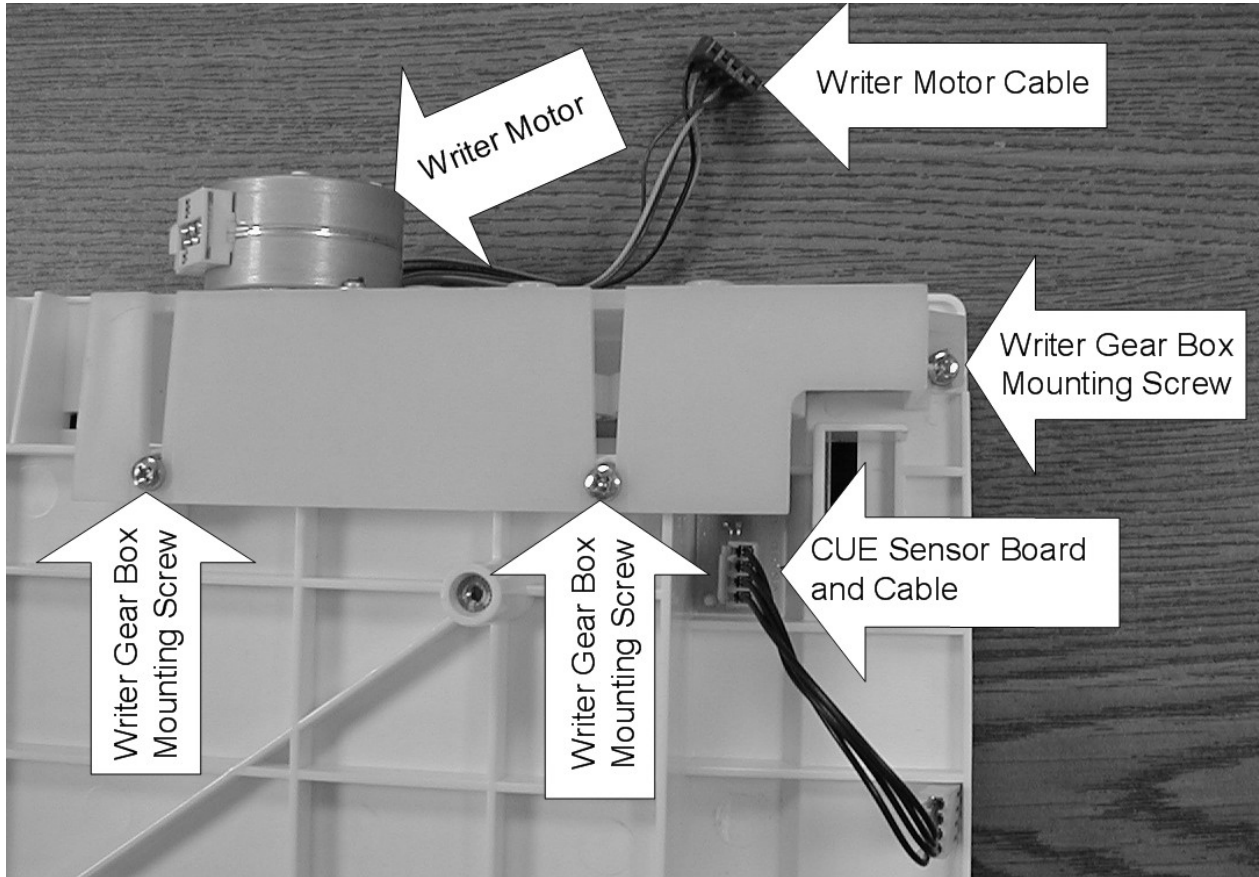

Remove the three screws that hold this assembly to the writer assembly, item number 53.

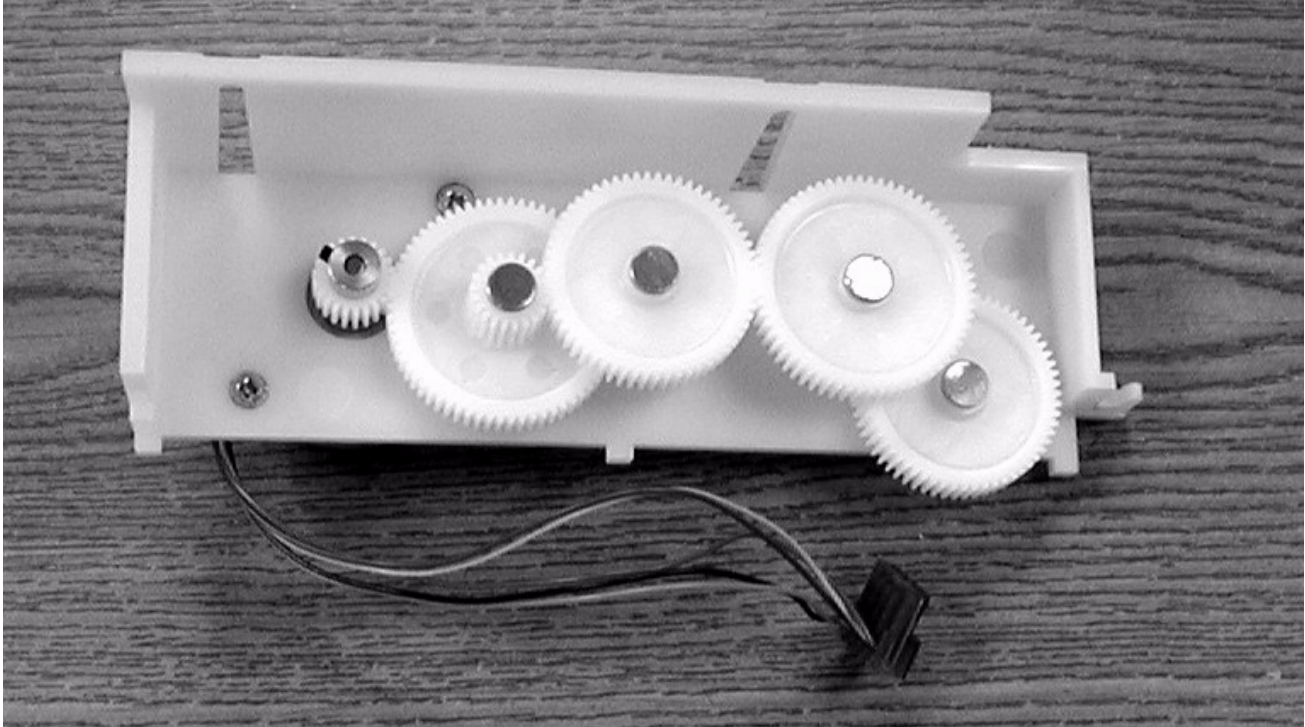

To remove the writer motor remove the two screws, item number 45, holding it to the gear assembly bracket. The writer motor will slide through the assembly.

Use a 0.05 inch or a 1.25 mm size Allen wrench to remove the gear from the writer motor. Re-assemble in reverse order.

Note: The screws holding the writer motor to the gear assembly bracket are coated with Vibra-tite to reduce the possibility of the screws vibrating loose. You may need to re-coat the screws to prevent vibration from loosening the screws.

Printed Circuit Board Assembly Removal / Installation



CAUTION

The Motherboard is a static sensitive part. Proper measures should be taken when handling this part.

When replacing the motherboard of the ELI 250/210 the configuration will need to be entered on the new board. Prior to replacement, if possible, copy or printout the configuration settings of the old board so that they can be entered when the new board is installed.

Remove the battery fuse from the fuse holder located beneath the unit near the front of the unit.

With the top cover and the writer assembly removed from the unit, locate and remove all cables from the motherboard.

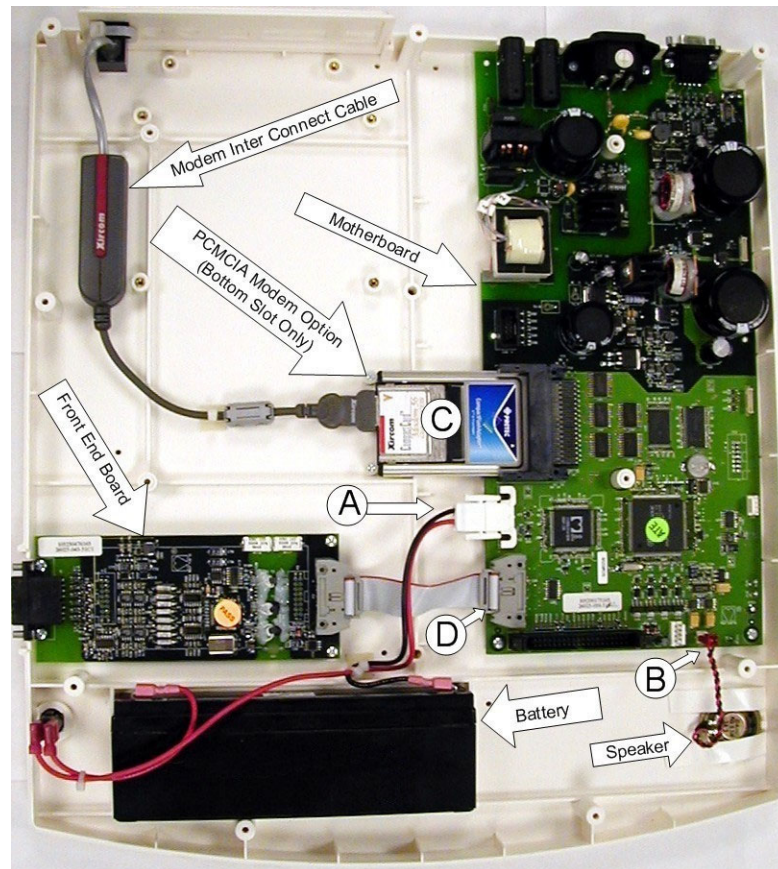

Remove the battery powerconnector (Labeled A), Remove the speaker cable (Labeled B) the modem PCMCIA board (Labeled C) and the Front End cable (Labeled D).

See Appendix B for additional boards available for this unit (Modem, LAN and Wireless LAN cards).

Once these cables are removed remove the 2 screws, item45, at the “front” of the board.

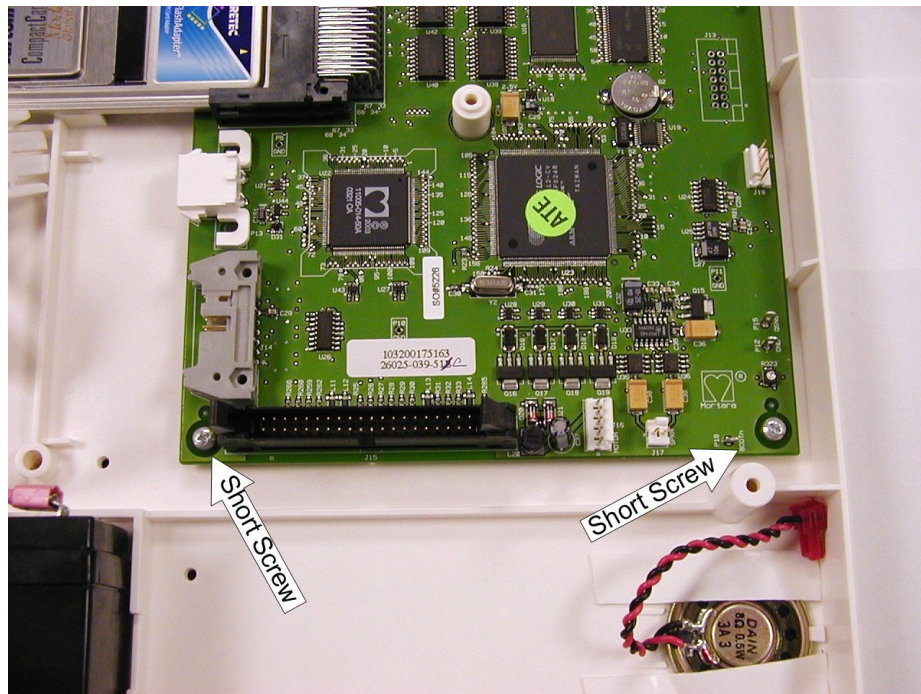

Remove the four screws, itemnumber46, at the back of the Motherboard.

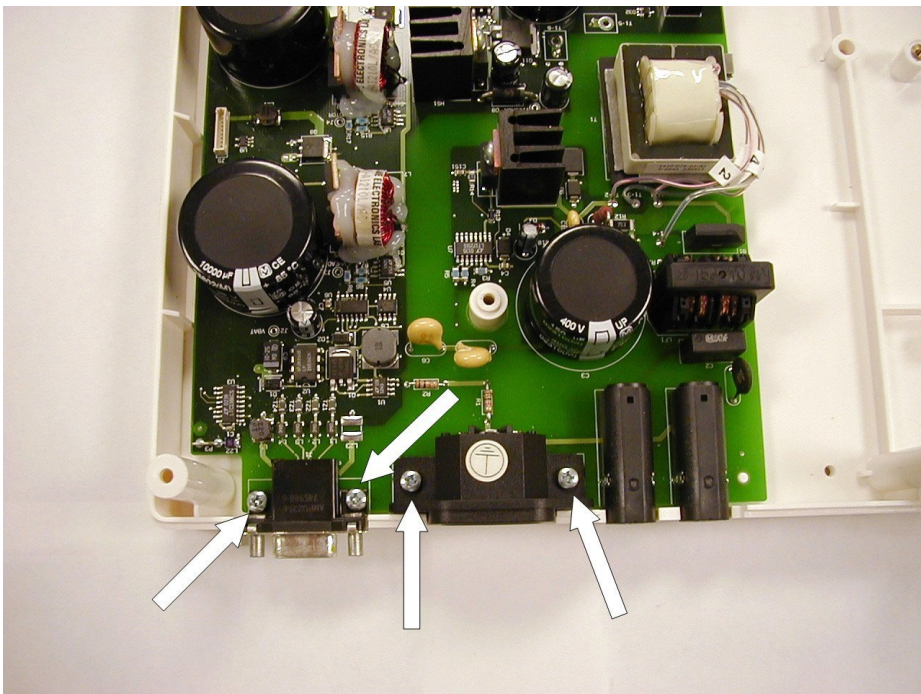

The Motherboard will now be loose and can be removed from the bottom chassis. Re-assemble in reverse order.



CAUTION

- 1.) *When installing a new board, do not replace the battery fuse until all cables have been connected to the board.*
- 2.) *The screws that hold the front of the motherboard down are shorter than the screws that hold the back of the motherboard down. Make sure that when installing the motherboard that the correct screws are used for the correct*

Front End Board Removal and Replacement

Locate the front-end board in the unit.

Remove the cable, item32, from the front-end board to the motherboard.

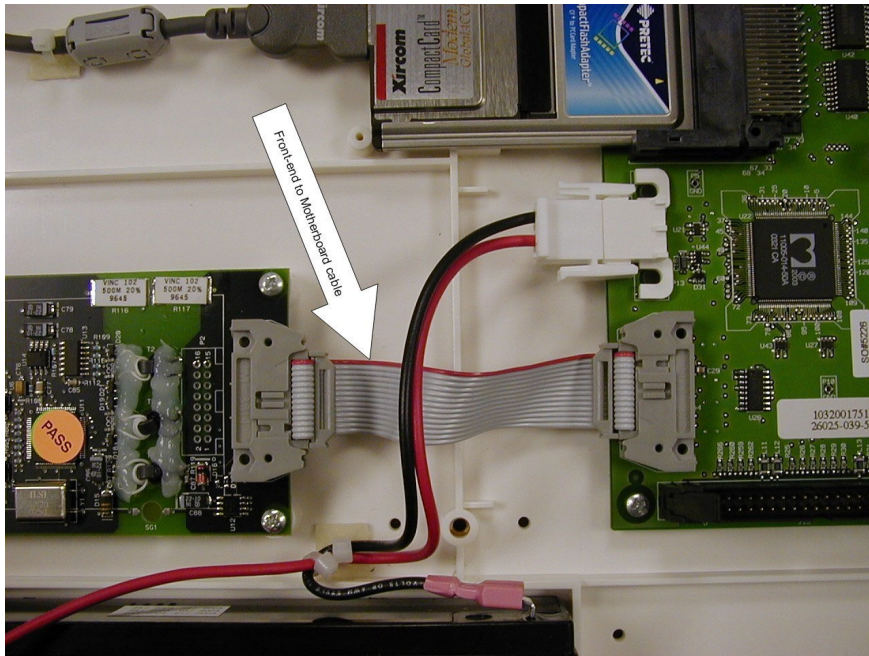

Locate the 4 screws holding the front-end to the chassis and remove.

Note: The screws located near the front end to motherboard interconnect cable will be shorter, item number 45, than those where the patient cable connects to the frontend board, item number 46. This is important when reassembling the unit.

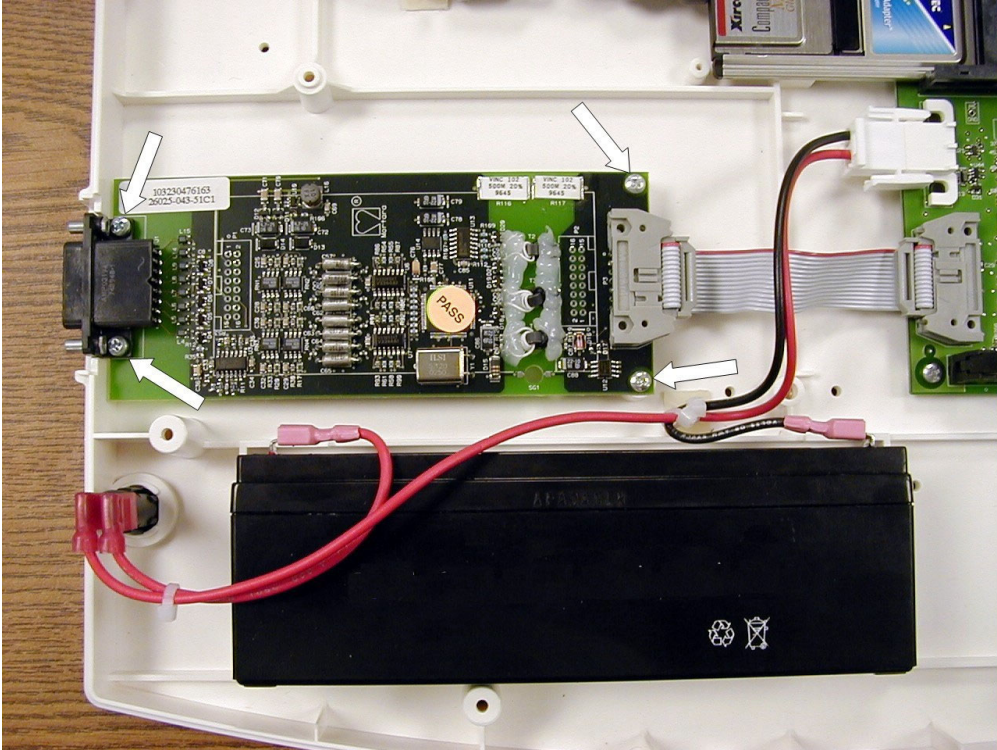

Lift the front-end out of the chassis.

Reassemble in reverse order.

TECHNICAL DESCRIPTION

Introduction

The WELCH ALLYN ELI 250/210 is an advanced interpretive electrocardiograph system utilizing the latest electronic technology and software. The ELI 250/210 offers 12-lead patient ECG monitoring, a 320 by 240 LCD display. A full function touchpad keyboard, 8-inch thermal writer for printing waveforms and interpretive data, a real-time electronic clock and calendar, an RS-232 level serial communications port, internal power supply, battery, and battery re-charge circuitry and optional internal MODEM. The system utilizes CMOS digital components to minimize power consumption and enhance performance. The ELI 250/210 is a modular assembly taking advantage of sub-assemblies designed at Welch Allyn, Inc.

The system consists of the following major sub-assemblies and parts:

- Main Systemboard (Motherboard) Assembly
- Front end board
- Keyboard and LCD Display
- Writer Assembly
- Battery
- Interconnect Cable Assemblies

The following page shows a block diagram of the ELI 250/210.

ELI 250/210 Block Diagram

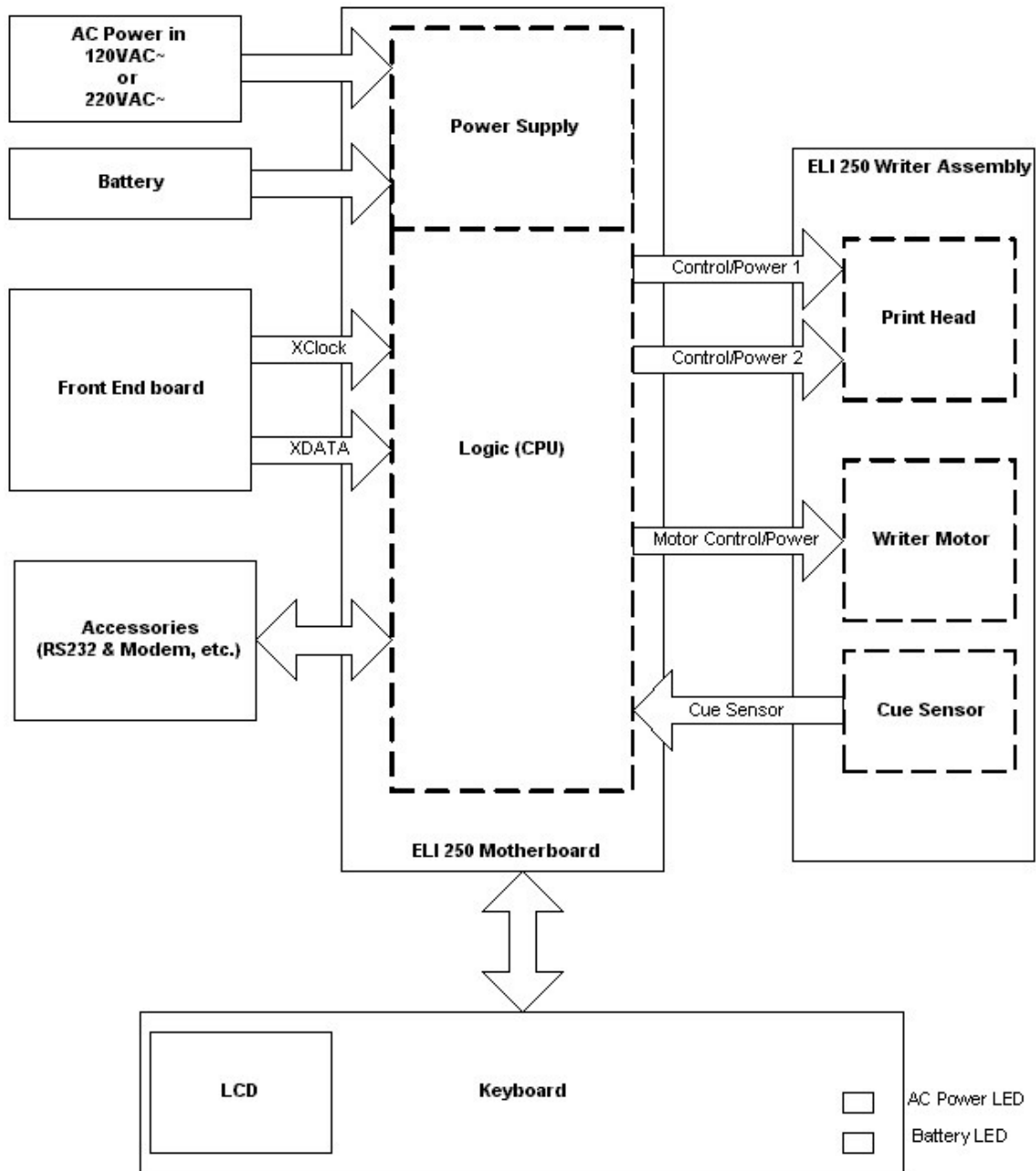

Main System Board

The main system board or motherboard of the ELI250/210 contains the digital logic circuitry and the power supply of the ELI 250/210. The rear section of the motherboard (located at what is the back of the unit when mounted in the chassis) contains the power supply of the unit.

Power Supply

The AC power supply consists of the AC inlet connector, AC inlet fuses and a switching power supply. The switching power supply automatically senses the input voltage coming in on the AC line and switches to supply the proper voltage to the unit.

The AC power supply powers the unit for operation and charges the internal battery. When the unit is not connected to an AC power source the internal battery will supply power to operate the unit.

Logic Circuitry

The logic circuitry or digital section of the motherboard contains the microprocessor, FLASH memory, Real time clock, LCD & keyboard control circuitry, interface circuitry for modem and RS232 communications, and the Writer interface circuitry.

Writer Interface

The writer interface on the motherboard consists of 5 connectors. Two of the connectors/cables connect directly to the thermal printhead of the writer. These two cables carry power, data and ground connections to the printhead. The third cable of the writer interface is for motor control and carries power, ground and stepper signals to the writer motor. The fourth cable is for the cue sensor and allows the motherboard to sensor when the paper is at the correct position to start printing. The fifth cable is an additional grounding wire for the printhead.

Accessories/Options

The motherboard has two PCMCIA slots on it for additional options to the unit. The lower PCMCIA slot is reserved for the optional modem and the upper slot is open for future options.

The ELI 250/210 also has a 9-pin RS232 port. This port serves two functions. The first is it allows software to be downloaded to the unit and the second, and most common, is for transmitting ECG's either to another unit or to a data management system.

Keyboard and LCD interface

The keyboard and LCD interface consists of a large ribbon cable that connects from the motherboard to the keyboard and LCD of the unit. This cable carries the data to the LCD and keyboard inputs to the motherboard.

Front End Board

The analog information from the patient enters the unit via the patient cable then enters the frontend board. The information is immediately digitized to create the 12 leads of ECG data. This digitized information is then sent to the motherboard via an interconnect cable. This interconnect cable carries power and ground from the motherboard to the front end and also carries serial clock and data from the front end to the motherboard. If the motherboard does not receive the clock and data signals from the front end, the LCD will not display any ECG waveforms.

Patient Input

Connector:	Pin #:	Name:	Description:
	1	V2	Patient Lead
	2	V3	Patient Lead
	3	V4	Patient Lead
	4	V5	Patient Lead
	5	V6	Patient Lead
	6	SHIELD	Isolated Front-End Ground
	7	Reserved	
	8	Reserved	
	9	RA	Patient Lead
	10	LA	Patient Lead
	11	LL	Patient Lead
	12	V1	Patient Lead
	13	Reserved	
	14	RL	Patient Lead
	15	Reserved	

Specifications

Feature	Specifications
Instrument Type	12-lead Electrocardiograph
Input Channels	Simultaneous acquisition of 12 leads
Standard Leads Acquired	I, II, III, aVR, aVL, aVF, V1, V2, V3, V4, V5, V6
Waveform Display	Backlit, 1/4 VGA LCD 3-channel lead groups or complete 8-channel presentation
Input Impedance Input Dynamic Range Electrode Offset Tolerance Common Mode Rejection	Meet or exceed the requirements of ANSI/AAMI EC11
Patient Leakage Current Chassis Leakage Current	Meet or exceed requirements of ANSI/AAMI ES1
Digital Sampling Rate	10,000 s/sec/channel used for pacemaker spike detection; 1000 s/sec/channel used for recording and analysis
Special Functions	Optional Mortara VERITAS resting interpretation algorithm; connectivity options for bi-directional communication; flash memory storage of ECGs
Paper Type	Full size (8.5" x 11" or A4), Z-fold thermal paper; 250 sheets stored in paper tray
Thermal Recorder	Computer-controlled dot array; 8 dots/mm
Thermal Writer Speeds	5, 10, 25, or 50 mm/s
Gain Settings	5, 10, or 20 mm/mV
Report Print Formats	Standard or Cabrera: 3+1, 3+3 channel, 6-channel, 12-channel
Rhythm Print Formats	6-channel with configurable lead groups or 12-channel
Keyboard Type	Elastomer keypad with complete alphanumeric keys, soft-key menu and dedicated function keys
Frequency Response	0.05 to 300 Hz
Filters	High performance baseline filter; AC interference filter 50/60 Hz; low pass filters 40 Hz or 150 Hz
A/D Conversion	20 bit (1.17 microvolt LSB)
Device Classification	Class I, Type CF defibrillation proof applied parts
ECG Storage	Up to 60 ECGs; optional expanded up to 150 ECGs
Weight	11.25 lb. (5.1kg) including battery
Dimensions	15.5" x 17" x 4" (39.4 cm x 43.2 cm x 10.2 cm)
Power Requirements	Universal AC power supply (100-240 VAC at 50/60 Hz) 50 VA. Internally rechargeable battery

* Note – The ECG Storage capability of the ELI210 is 1 ECG

Parts List

Item Number	Part Number	Description
1	26025-039-XX	Motherboard PCB Assembly
2	26025-039-XX	Motherboard PCB Assembly
3	26025-040-51	Keyboard PCB Assembly ELI 250
4	26025-051-50	Keyboard PCB Assembly ELI 210
5	26025-043-XX	10k+ Front End Amplifier PCB Assembly
6	4021-001	Fuse Type T, 250V, 1A, 5 x 20MM SLO
7	4021-006	Fuse, 5 AMP, TYPE T, SLO BLO 250V
8	4110-006	Fuse Holder, 5 x 20 Panel Snap-In mount
9	4160-026-51	Elastomeric Keypad ELI 250
10	4160-027-50	Elastomeric Keypad ELI 210
11	4800-006	Rechargeable Battery, 12V, 2.2Ah
12	5400-014	LCD Panel 320 x 240, 3.9" mono
13	5450-004	Thermal Printhead, 216mm 8.50"
14	6545-006-01	Stepper motor PM 35mm 1-2PH 48 STEP/R
15	6570-842-02	Platen / Shaft 8.421 x .551
16	690-1225	Lithium Battery, 3V, 38 mAH SM
17	8342-001-XX	Upper Housing
18	8342-002-XX	Lower Housing
19	8342-003-XX	Paper Tray Cover
20	8342-004-50	Gear Box Assembly
21	8342-005-XX	Paper Tray
22	8342-015-50	Keyboard Bezel ELI 250
23	8343-001-50	Keyboard Bezel ELI 210
24	8342-016-XX	Bulkhead Back Panel
25	8342-021-50	LCD Bezel ELI 250
26	8343-002-50	LCD Bezel ELI 210
27	9050-055-01	Nameplate Label ELI 250
28	9042-030-01	Nameplate Label ELI 210
29	9205-062-50	Shipping Carton Assembly
30	9042-030-XX	Label User Instructions
31	9042-035-01	Bulkhead Label Blank
32	25018-035-50	Cable assembly 14 conductor
33	25020-053-50	Speaker assembly
34	25018-036-50	Keyboard to Motherboard cable
35	25020-059-51	Cable assembly battery to PCB
36	6320-003	Adhesive rubber foot
37	9042-033-01	AC/Battery charged label
38	8342-021-XX	LCD Bezel
39	26025-050-50	Bulkhead conn PCB assembly
40	25018-037-50	Cable assembly 2nd serial port
41	9960-041	Wireless LAN 2.4 GHz Card
42	8342-024-01	Bracket CF Card Stabilizer
43	26025-045-51	Cue Sensor PCB Assembly

Hardware

Item Number	Part Number	Description
44	6020-430	Screw Phillips Panhead M3x6
45	6020-530	Screw Phillips Panhead M3x5
46	6020-831	Screw Phillips Panhead M3x8
47	6020-930	Screw Phillips Panhead M3x10
48	6095-001	Screw Phillips Self-tapping M2.2x9.5mm long
49	7401-003	Tape 2 Sided adhesive 0.031 thick X 0.50 wide
50	7401-002	Tape Two-sided adhesive 0.09 thick X 0.25 wide
51	7401-005	2 sided VHB Acrylic 3M 0.045 thick X 0.75 wide
52	6020-430-02	Screw Phillips Panhead M3x6 Coated With Vibratite
53	6020-730-02	Screw Phillips Flat M3x6 Coated With Vibratite
54	9960-040	Compact Flash to PCMCIA Adaptor
55	9910-015	Xircom Compact FLASH modem W/Cable
56	6400-002-01	Cable W/Modular Phone Plugs
57	26025-056-50	ELI2XX LAN Card PCB Assembly
58	26025-063-50	LAN Interface PCB Assembly
59	6400-010	Cable Ethernet CAT5e RJ45 M SHLD 2FT
60	25020-061-50	Cable Assy LAN LED ELI 2XX
61	26025-059-50	MULTITECH Modem Interface PCB Assembly
62	25018-037-50	Cable Assembly ELI 250 INTRNL 2ND Serial Port
63	7495-001	Cable Tie/Tie Wrap 3.9 X 0.10

Troubleshooting and Testing

Introduction

Since repair of the ELI 250/210 is limited to replacement of subassemblies the troubleshooting guide does not extend to the component level

NOTE: Remove the battery fuse and AC power during any disassembly necessary for servicing.

Troubleshooting

AC power connected to unit, back-light is on, nothing on display.

- 1) Check AC fuses.
- 2) Does unit power up on battery?
 - A) If yes, there is an AC power supply problem. Replace the motherboard.
 - B) If no, power supply or battery problem. Replace motherboard and check battery for possible replacement.
- 3) Check Keyboard/LCD cable going to the keyboard and the motherboard. If disconnected reconnect and test again.
- 4) Replace the Keyboard/LCD cable.

With AC power on nothing displayed on LCD

- 1.) Press any key on the keyboard. If speaker tone is heard there is a possible LCD problem. Replace LCD.

Unit works on AC power but not on battery

- 1) Check battery fuse.
- 2) Open unit and check battery connections.
- 3) Replace battery.

Unit turns on, no waveform is displayed but function key options are displayed.

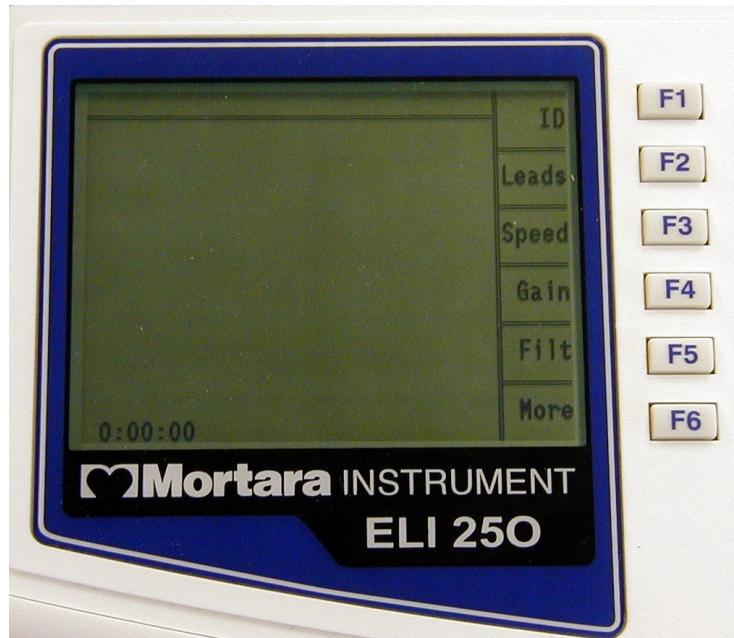

Press any key on the keyboard, if no response there is a possible communications problem between front end board and motherboard.

- 1) Replace cable between front end and motherboard.
- 2) Replace front end board
- 3) Replace motherboard

No keyboard functions and LCD is frozen

Note: It is possible that the LCD may be active but not receiving new data

There is a software problem.

- 1) Remove AC power from the unit.
- 2) Press and hold the On/Off key for 10 seconds. Unit should turn off.
- 3) Wait 10 seconds then turn the unit on again. Unit should start to respond correctly.

Or

- 1) Remove AC power.
- 2) Remove battery fuse from unit and leave out for 10 seconds.
- 3) Install battery fuse.

RS-232 Transmit/Receive Problems

Make sure that the baud rate set in the configuration matches that of the system that is being transmitted to or received from. If the baud rate is set correct there is a problem with either the transmission cable or the RS232 portion of the motherboard and the motherboard should be replaced.

Optional Modem Transmit/Receive Problems

If the unit does not transmit via the modem the first item to check is the configuration. Make sure that a telephone number is entered and that the number is correct. The next item to check is the modem initialization string (please see the configuration section of this manual or the operator manual).

Testing

Power Supply Test

- 1.) Remove battery fuse and AC power from the unit.
- 2.) Open unit to access the connections to the battery.
- 3.) Remove one of the battery cables from its terminals.
- 4.) Connect DMM set to a current setting to measure the current that the unit is using.
- 5.) Install the battery fuse and measure the unit "OffCurrent" (<40uA)
- 6.) Turn the unit on and measure the current draw from the battery. This should read less than 250mA.
- 7.) Verify that the ACLED on the keyboard is not on.
- 8.) Increase the setting on the DMM to the 2000 mA range.
- 9.) Apply AC power to the unit and verify that the current reading on the battery does the following
 - A.) Reverses polarity
 - B.) That the value starts decreasing as time increases. (this indicated that the battery is charging).
 - C.) That the ACLED is now "ON"
- 10.) Disconnect the positive battery terminal and measure the voltage coming from the charger, it should be between 13.0 and 14.0 vdc.
- 11.) Remove AC power and the battery fuse.
- 12.) Remove the DMM and reconnect the battery cable to the battery.
- 13.) Close the unit.

Keyboard Test

- 1.) Turn Unit on.
- 2.) Press the F1, ID, key.
- 3.) Start pressing the alpha keys on the keyboard and verify that they are displayed on the screen. When the characters reach the end of the line, press the enter key and continue entering characters in the First Name field.
- 4.) If all characters are present the test has passed. If any of the characters are not displayed there is a possible keyboard problem.

LCD Test

- 1.) Turn the unit on.
- 2.) Apply an input signal from a simulator.
- 3.) Verify that there are no gaps, missing segments or large black areas on the screen.
- 4.) Enter the configuration of the unit.
- 5.) Locate the Contrast setting for the display.
- 6.) Change the contrast setting to full and then decrease the setting. Verify that the screen goes fully dark and then blank.
- 7.) Reset the contrast to an acceptable level.

Speaker Test

- 1.) Turn the unit on.
- 2.) Press the F6, More, key.
- 3.) Press the number 3 key to select the "Date & Time" option.
- 4.) Press the following key strokes to access the configuration options: ALT + Shift + C
- 5.) Page through the configuration to find the Volume option.
- 6.) Highlight the Volume option and increase the value by pressing a number key, note that the tone emitted by the speaker.
- 7.) Test different values from 0, turns the speaker off, to 8, maximum value. With each change the volume of the tone should change accordingly.
- 8.) If the tone does not change, replace the speaker.
- 9.) If replacing the speaker does not resolve the problem the motherboard needs to be replaced.

Date / Time Test

- 1.) Turn the unit on.
- 2.) Press the F6, More, key.
- 3.) Press the number 3 key to select the “Date & Time” option.
- 4.) Enter the current date and time into the unit.
- 5.) Press the F5 Save option to save the changes.
- 6.) Press the F6 Exit option to return to the main menu of the unit.
- 7.) Observe the time in the lower left corner of the display it should beset to the correct time.

If the date and time are not retained there is a motherboard problem and replacement of the motherboard is recommended.

Writer Tests

From the main menu press and hold the following key combination **Alt+Shift+RHY**. The following test strip will be printed.

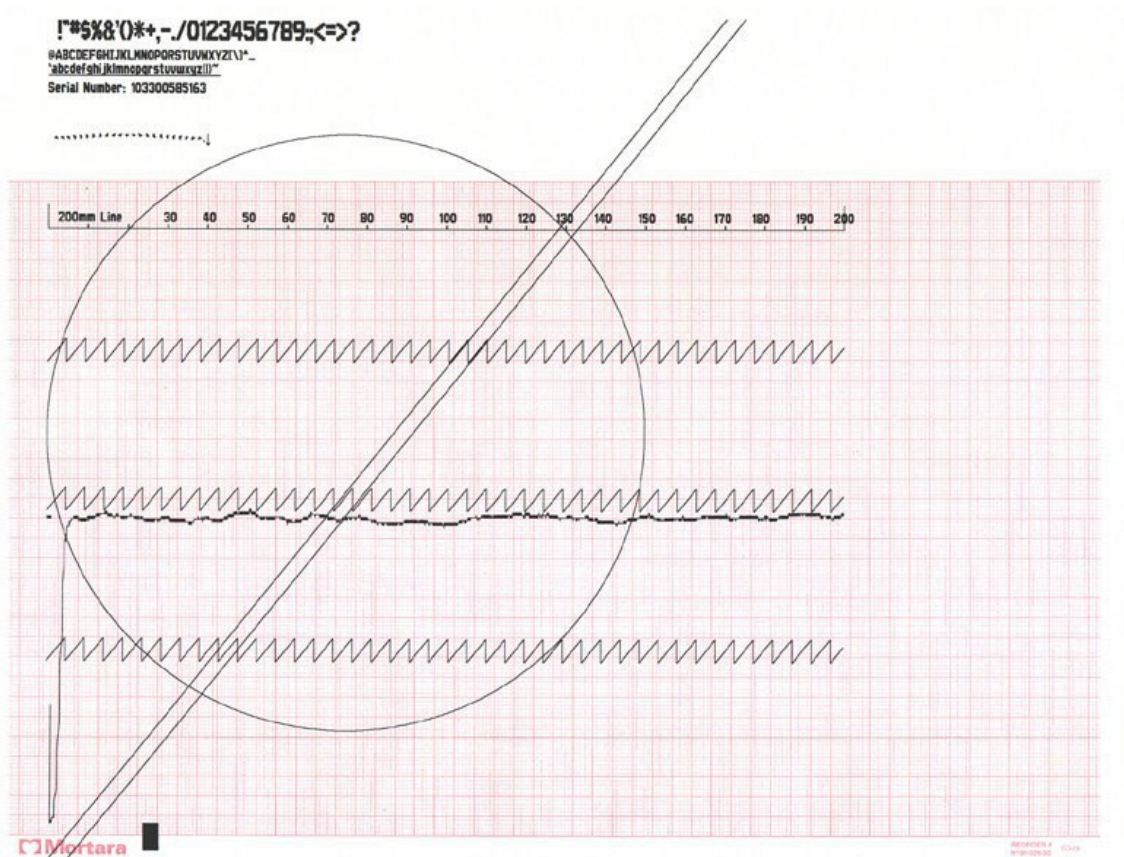

Note: This test should be performed with the AC power connected to the unit.

The Configuration Filter setting will have an affect on the way that the circle prints out. If the filter is set to 300Hz, the circle will be complete as shown above. If the filter is set to a setting less than 300Hz the circle will have a gap on the right side and not be a smooth circle.

Description of printout

At the top of the writer test printout will be the printable characters of the writer.

The next section will have a 200-mm line. This line should be measured with a ruler and will indicate if there is a writer motor problem if the line is too short or too long. The tolerance of this line is +/- 2-mm.

The next line that prints is a zigzag line. Check to see that none of the dots are missing.

The next line that prints is an indication of the cue sensor. At the beginning of the printout there should be a dip towards the bottom of the page and then it should move to a baseline level. *Note: there will be fluctuation in this line, this is normal. Look for extreme variations that can indicate possible problems with the cue sensor or cue sensor circuitry.*

There will then be two additional lines of zigzag printed. Check to see that none of the dots are missing.

At the bottom of the page, starting in the lower left and continuing to the top of the page, two diagonal lines will be printed. Check these lines for any missing dots. If dots are missing the print head may need to be cleaned or replaced. Also check the lines for any "steps" which can indicate a motor problem.

Another item that is printed is a circle. Check the circle to make sure that there are no breaks or gaps in the printing. This can indicate a problem with the writer motor and the thermal printhead.

When printing an ECG at different paper speeds the calibration pulse printed at the beginning of each trace can be used to check the paper speed. Check the calibration pulse by measuring the width and amplitude of the pulse at the beginning of each line of ECG tracing. Use the following table for the correct measurements.

Note: The measurements should be made using a ruler and not the grid on the paper.

Paper Speed	Cal Pulse Width
5mm/sec	1mm
10mm/sec	2mm
25mm/sec	5mm
50mm/sec	10mm
Gain Setting	Cal Pulse Amplitude
5mm/mV	5mm
10mm/mV	10mm
20mm/mV	20mm

Adjusting the Writer Cue Sensor

Note: This test should be performed with the AC power turned on.

- 1) Install paper into the unit with the cue mark approx. 1 – 2 inches away from the tear bar. Make sure that the cue sensor is seeing white and not any markings on the paper.
- 2) Use a DMM to measure the DC voltage at test point P15 on the motherboard with respect to ground (P12). Adjust R323 on the motherboard to between 1.95 V-DC and 2.05 V-DC at test point P15. Set this as close to 2.0 V-DC as possible.
- 3) Perform either the Writer test or print a test ECG. The paper should cue to the next sheet of paper, print and then advance to the beginning of the next sheet of paper.
- 4) If the Writer test is performed the results should be compared with the test printout in this manual.

ECG Test

- 1.) Connect a simulator to the patient cable and connect the patient cable to the unit.
- 2.) Turn the unit on.
- 3.) Press the F1 key and enter a test patient name.
- 4.) Press the Auto key. The unit will acquire the ECG and depending on the units' configuration, will print the ECG.
- 5.) Verify that the printed ECG is correct for the simulated input to the unit.

Noise Test

Perform the noise test using a shorting plug of the following design.

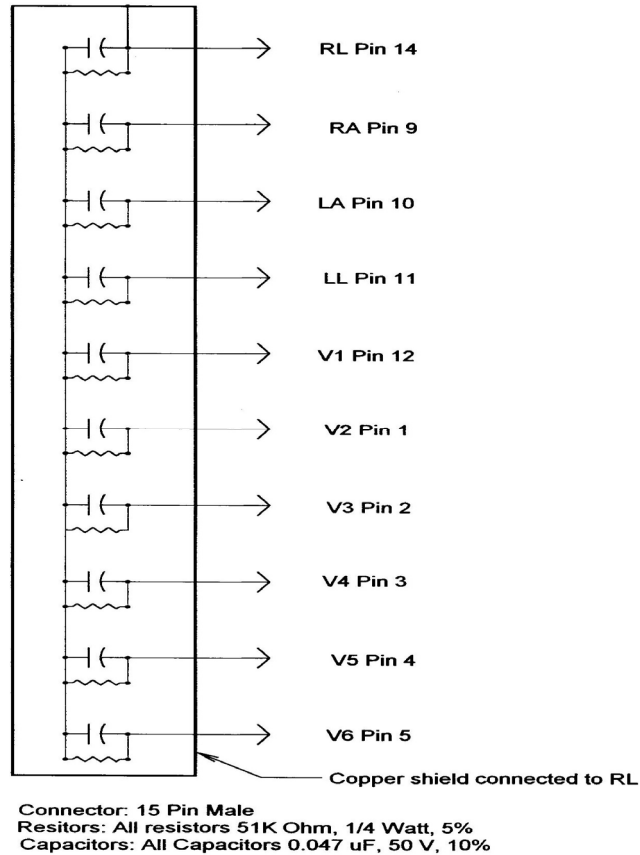

Please note that Welch Allyn does not supply this shorting plug

- 1.) Turn the unit on with the shorting plug connected to the input connector of the unit.
- 2.) Increase the gain of the unit to 20mm/mV.
- 3.) Select the **RHY** button to print a rhythm strip.
- 4.) After 200 mm of paper have printed, press the **Stop** button to stop the printout.
- 5.) Visually inspect the baseline of the rhythm strip for any peaks greater than 0.5 mm. If there are no peaks greater than 0.5mm the test is successful.

Lead Fail Test

Perform the lead fail test as follows:

Connect the patient cable to a simulator or a shorting bar. Disconnect one lead at a time from the simulator or Shorting bar and verify that the correct lead fail message appears on the LCD while in the Main Menu screen. Only the message for the disconnected lead should appear as shown below.

Lead	Message
Right Arm	LEAD RA OFF
Left Arm	LEAD LA OFF
Left Leg	LEAD LL OFF
V1	LEAD V1 OFF
V2	LEAD V2 OFF
V3	LEAD V3 OFF
V4	LEAD V4OFF
V5	LEAD V5 OFF
V6	LEAD V6 OFF
All Leads off	LEADS OFF

Transmitting Records

You may transmit ECGs from the ELI 250/210 to another Welch Allyn electrocardiograph or to an E-Scribe Data Management System using a direct connection or an optional factory installed internal modem.

Before transmitting ECGs to E-Scribe, the site number must be defined as well as the telephone number in the configuration.

NOTE: Telephone transmission is available with modem option only.

To transmit records (either to another cardiograph or to E-Scribe), select the **XMT Key** . The following screen is displayed:

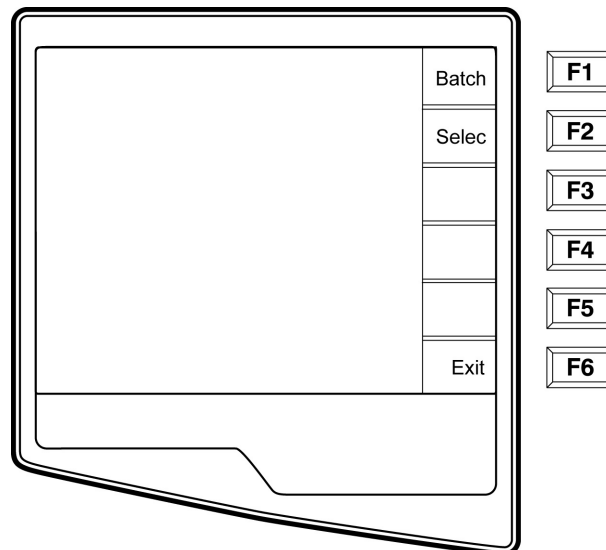

To batch transmit of all records in the directory, select **F1 (Batch)**. If a batch transmission is selected, only those records which have not been previously transmitted or marked deleted will be transmitted.

An ECG may be listed in the directory but have a “deleted status” (indicated by “X”). The directory saves those records that have been marked for deletion in the event that you may want to recover the ECG at a later time. All

stored ECGs will remain in the directory until it becomes full, at this time, the ELI 250/210 will automatically remove a record, based on its size, in order to make room for the new ECG. Only those records that have been marked for deletion will be removed. Records are automatically marked for deletion based on the Delete Rule configuration. To manually mark an ECG record for deletion, press **Delete (F4)** and an “X” will appear in the far-right hand column of the directory and to remove the delete status, select **F4** again.

To transmit one ECG, select **F2 (Select)** to choose a record from the patient directory.

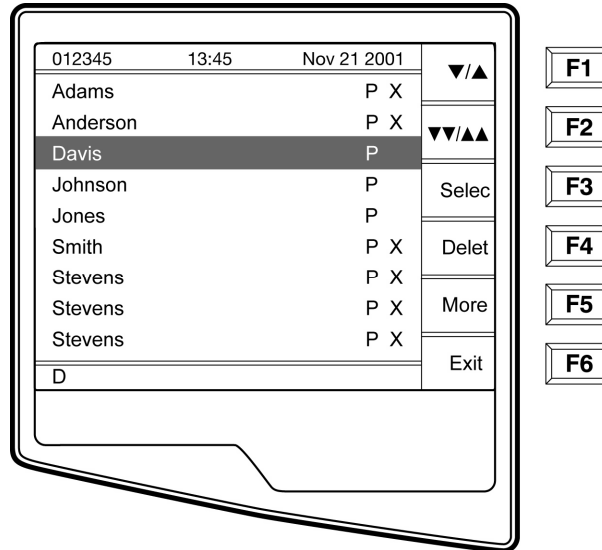

Use **(F1)** to navigate down the directory list and **Shift (F1)** to move up the list. Similarly, use **(F2)** to page down and **Shift (F2)** to page up through the directory. To quickly find and select a patient name, use the keyboard to enter the first letter(s) of the last name. The letters will be displayed on the lower left corner of the LCD and the desired name will automatically be highlighted. When the desired record is highlighted, use **F3 (Select)** to transmit the individual ECG.

The following screen appears during a batch transmission or for a single record transmission:

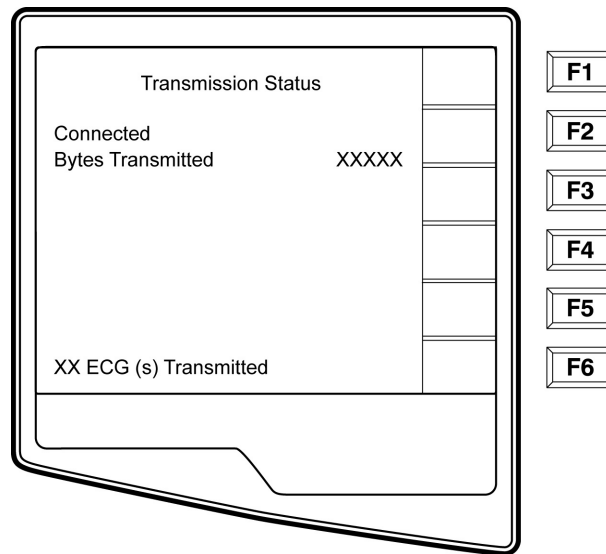

After the transmission of your record(s), the Real-Time ECG View is displayed.

Serial Port Test (Direct connect transmission)

For a direct connection hookup, connect the ELI250/210 to another ELI250/210 with a direct connect serial cable (Welch Allyn P/N: 25000-024). Plug each end of the cable into the serial ports (RS232).

In the configuration setting, select a baud rate of 9600 or 38400 bps for both units.

See above section on Transmitting Records to perform the test transmission.

Modem Test

Modem Transmission

For a modem transmission, connect the ELI250/210 to a standard telephone jack with the provided phone line cable. Plug the cable into the telephone jack located on the back of the cardiograph and the other end into a telephone wall jack. Confirm telephone number in the configuration settings (see the System Settings sc of Operator's manual).

Modem Initialization

The modem initialization string is country specific. At the time of production, the modem initialization string is configured for the country of purchase. However, if the unit is relocated to a different country, the modem initialization string will need to be modified.

From the Real Time ECG View, select **F6 (More)** to display the Application Menu.

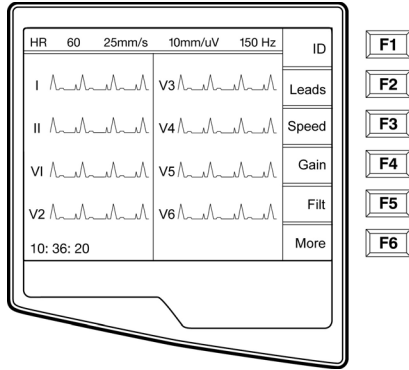

Real Time ECG View

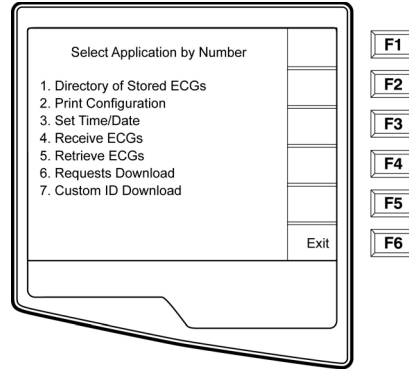

Application Menu

From the Application Menu, simultaneously press **ALT+SHIFT+M** to access the modem initialization string. The following screens appear:

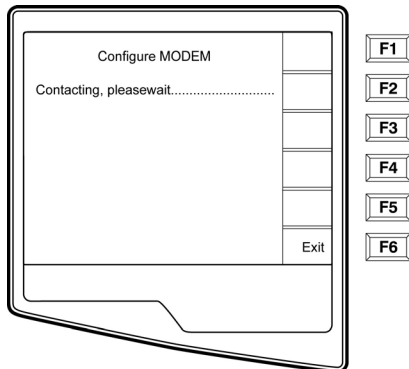

Approximately 30 second delay

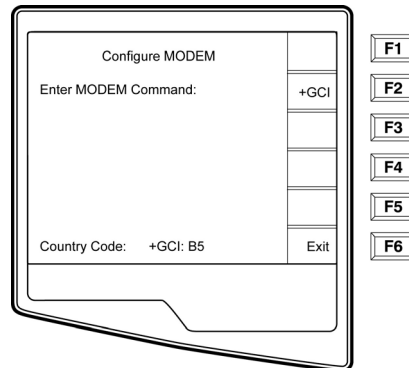

Select **F2 (+GCI=)** to populate the prefix “**AT+GCI**” of the modem command.

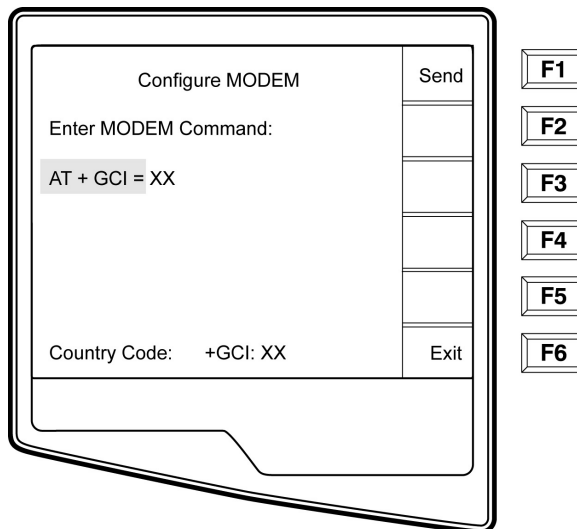

TIP: “AT+GCI” will be highlighted– cursor is not present – use keypad to enter country code.

Enter your country code as listed below. Select **F1 (Send)** to change your country code. “Command stored” will be displayed. Select **F6 (Exit)** to return to the Application Menu.

Country	Code	Country	Code
Argentina	07	Liechtenstein	68
Australia	09	Luxembourg	69
Austria	0A	Japan	00
Barbados	0E	Korea	61
Belgium	0F	Malaysia	6C
Brazil	16	Mexico	73
Canada	20	Netherlands	7B
Czech Republic	2E	New Zealand	7E
China	26	Norway	82
Denmark	31	Poland	8A
Finland	3C	Portugal	8B
France	3D	Russia	B8
Germany	04	South Africa	9F
Greece	46	Singapore	9C
Guam	48	Slovak Republic	FC
Hungary	51	Spain	A0
Hong Kong	50	Sweden	A5
Iceland	52	Switzerland	A6
India	53	Taiwan	FE
Indonesia	54	Thailand	A9
Ireland	57	United Kingdom	B4
Israel	58	United States	B5
Italy	59	Venezuela	BB

Receive ECGs

To receive ECGs from another Welch Allyn electrocardiograph (using either a telephone or a direct connection), select **Receive ECGs (4)** from the Application Menu.

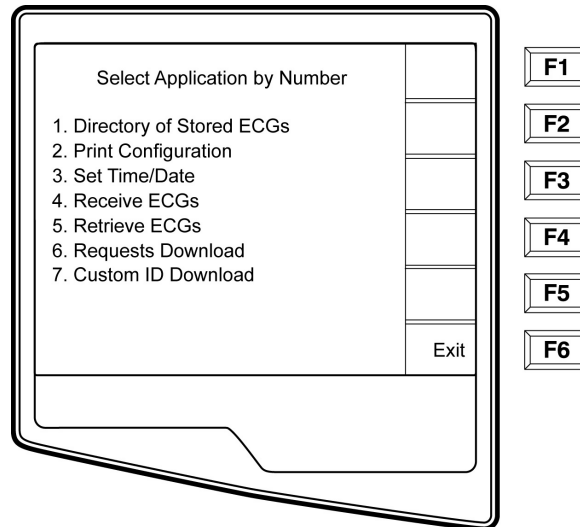

The LCD displays the following message:

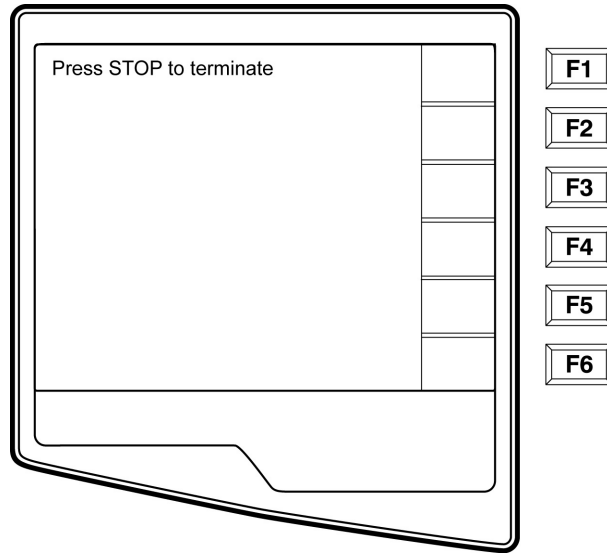

When the LCD displays the above message, the unit is ready to receive the ECGs from the transmitting electrocardiograph. Follow the instructions on transmitting records as described in this section. The receiving unit only acts as a printer. Received ECGs will not be viewed or stored. To terminate the receiving mode, press the **STOP** key.

Note: The ELI 250/210 will receive records from Welch Allyn model cardiographs. The Welch Allyn model cardiographs (ELI 100, ELI 200, Landscape, and Portrait) will not receive the ELI 250/210 records.

WLAN Test

The following test requires a properly configured access point and test software to receive ECG data from the UUT. It is recommended to setup the test configuration to use DHCP, WEP key encryption, and channel 6; however, this is not a requirement.

Note- The cardiograph uses WEP keys 0-3, these may not correspond directly to your access point WEP keys if it uses keys 1-4. (See example in table)

Linksys	Cardiograph
1	0
2	1
3	2
4	3

From the main menu press the “more” key.

Select “system configuration” and page to the menu screen containing the WLAN settings.

Set the “Default XMT Media” to WLAN and install your network information; the following settings are required in the cardiograph and should be obtained from your local network personnel:

Host IP address	(network specific)
Port #:	5005
SSID:	(access pointname)

Channel Number: 6
WEP info (if used)

Once this setup is completed ECGs can be transmitted by pressing the “XMT” key from the main menu and selecting the record you wish to send.

Transmission information can be viewed in the test software window.

When completed the UUT display will return to the ECG directory and a “T” flag will be set indicating proper transmission. The transmitted ECG can be seen in the target directory (C:\UNIPRO) listed as a new file.

Safety Tests

If the cardiograph housing was opened for repair or inspection work, the following safety tests should be performed in accordance with the EN/IEC 60601-1 or EN 62353/IEC 62353 methods and limits.

In countries with different national legislation, the country specific standards and guidelines for retesting of electrical medical devices are obligatory.

Objective evidence of testing results versus the defined standards should be provided as part of the servicing record.

The following tests are performed per the above specifications:

- ACHi-Pot Patient to Mains
- Earth Leakage
- Enclosure Leakage
- Patient Source
- Patient Sink

ELI250/210 TEST DATA RECORD

Unit Serial #: _____

- Device Cleaning
- Print device configuration (Attach to this report)
- Power Testing
 - 1. Note Battery Age (If not possible enter N/A) _____ / _____ (week/year)
 - 2. Off Current _____ uA (<40uA)
 - 3. On Current _____ mA (<250mA)
 - 4. Charging current flow + AC LED PASS/FAIL (Circle one)
 - 5. Battery Charger Output Voltage _____ VDC (13.0-14.0 VDC)
- Functional Testing
 - 1. Keyboard Test PASS/FAIL (Circle one)
 - 2. LCD pixel check PASS/FAIL (Circle one)
 - 3. LCD Contrast PASS/FAIL (Circle one)
 - 4. Speaker Test PASS/FAIL (Circle one)
 - 5. Time/Date PASS/FAIL (Circle one)
- Writer Assembly / Cue Sensor Adjustment (see Appendix A:1):
 - 1. Mechanical Operation PASS/FAIL (Circle one)
 - 2. Print Head Alignment PASS/FAIL (Circle one)
 - 3. Print Quality PASS/FAIL (Circle one)
 - 4. Cue Sensor Calibration _____ VDC (1.95-2.05 VDC) PASS/FAIL (Circle one)
 - 5. Operational Gear Meshing PASS/FAIL (Circle one)
 - 6. Writer Tracking PASS/FAIL (Circle one)
- Analog Front End Testing:
 - 1. ECG Throughput Test PASS/FAIL (Circle one)
 - 2. ECG Noise Test PASS/FAIL (Circle one)
 - 3. Lead Failure Test PASS/FAIL (Circle one)
- Communication Options (based on options present)
 - 1. RS232 PASS/FAIL/NA (Circle one)
 - 2. Modem PASS/FAIL/NA (Circle one)
 - 3. LAN PASS/FAIL/NA (Circle one)
 - 4. WLAN B, G or G2 PASS/FAIL/NA (Circle one)
- Safety Testing PASS/FAIL (Circle one)

Performed by: _____

Date: ____ / ____ / ____

Appendix A ELI 250 Connectivity

Chapter Purpose

This chapter is intended to provide the user with:

- Transmitting Records
 - Direct
 - Modem
 - WLAN
 - LAN
- ECG Receiving instructions
- ECG Retrieving instructions
- Requests Download
- CustomID

Transmitting Records

You may transmit ECGs from the ELI 250 to another Welch Allyn electrocardiograph, to an E-Scribe Data Management System, or to ELI LINK using a direct connection, an optional factory installed internal modem, or network connection.

Before transmitting ECGs certain configuration options must be set depending upon the optional transmission media being used (see System Settings Section).

NOTE: Telephone transmission is available with modem option only.

To transmit records (either to another cardiograph, to ELI LINK or to E-Scribe), select **XMT** . The following screen is displayed:

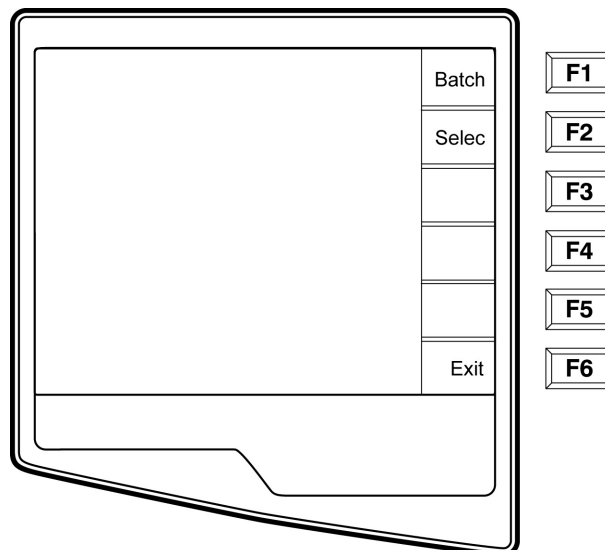

To batch transmit of all records in the directory, select **F1 (Batch)**. If a batch transmission is selected, only those records, which have not been previously transmitted or marked deleted, will be transmitted.

An ECG may be listed in the directory but have a “deleted status” (indicated by “X”). The directory saves those records that have been marked for deletion in the event that you may want to recover the ECG at a later time. All stored ECGs will remain in the directory until it becomes full, at this time, the ELI 250 will automatically remove a record, based on its size, in order to make room for the new ECG. Only those records that have been marked for deletion will be removed. Records are automatically marked for deletion based on the Delete Rule configuration. To manually mark an ECG record for deletion, press **Delete (F4)** and an “X” will appear in the far right hand column of the directory and to remove the delete status, select **F4** again.

To transmit one ECG, select **F2 (Select)** to choose a record from the patient directory.

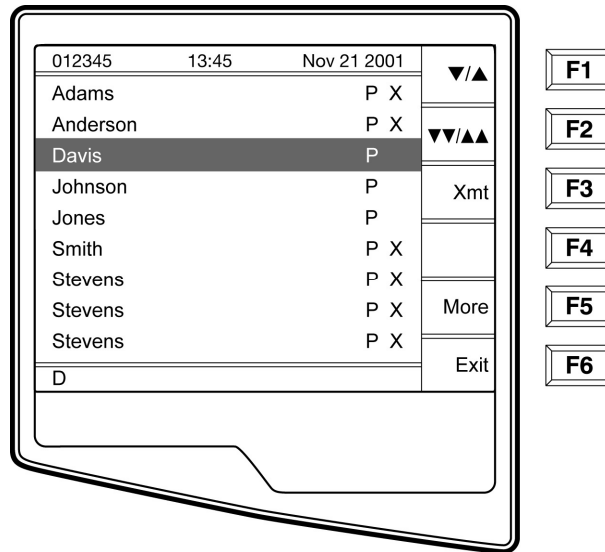

Use **(F1)** to navigate down the directory list and **Shift (F1)** to move up the list. Similarly, use **(F2)** to page down and **Shift (F2)** to page up through the directory. To quickly find and select a patient name, use the keyboard to enter the first letter(s) of the last name. The letters will be displayed on the lower left corner of the LCD and the desired name will automatically be highlighted. When the desired record is highlighted, use **F3 (XMT)** to transmit the individual ECG.

The following screen appears during a batch transmission or for a single record transmission:

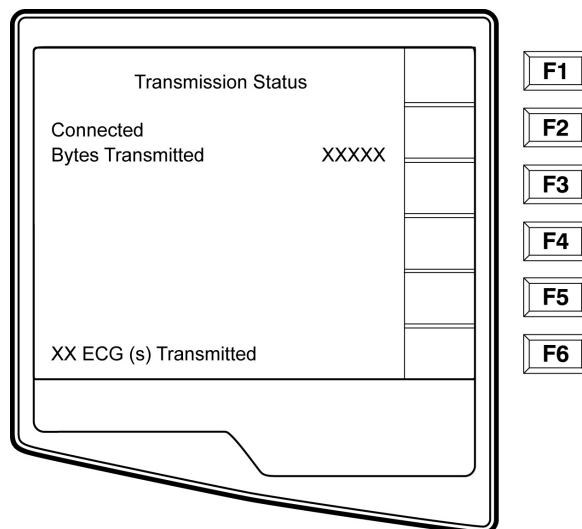

After the transmission of your record(s), the Real-Time ECG View is displayed.

Direct Connection

For a direct connection hookup, set the Default XMT media to RS232 from Configuration page 6 (see System Settings section of this manual). Connect the ELI250 to another Welch Allyn electrocardiograph, to the E-Scribe, or to ELI LINK with a direct connect serial cable.

In the configuration setting, select matching baud rates for both units. Use 38400 bps for a direct connection to E-Scribe.

Modem Transmission

For a modem transmission, set the Default XMT media to Modem from Configuration page 6 (see System Settings section of this manual). Connect the ELI 250 to a standard telephone jack with the provided phonenumber cable. Plug the cable into the telephone jack located on the back of the cardiograph and the other end into a telephone wall jack. Confirm telephone number in the configuration settings (see System Settings section of this manual).

Modem Initialization

The modem initialization string is country specific. At the time of production, the modem initialization string is configured for the country of purchase. However, if the unit is relocated to a different country, the modem initialization string will need to be modified.

From the Real Time ECG View, select **F6 (More)** to display the Application Menu.

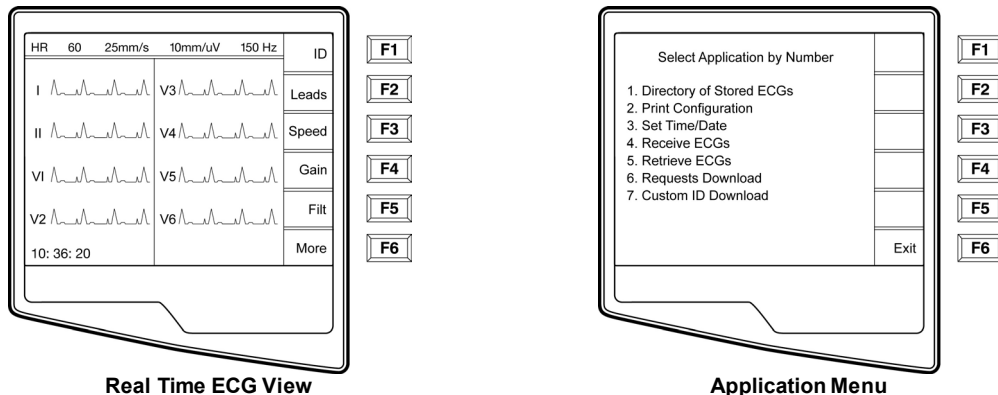

From the Application Menu, simultaneously press **ALT+SHIFT+M** to access the modem initialization string. The following screens appear:

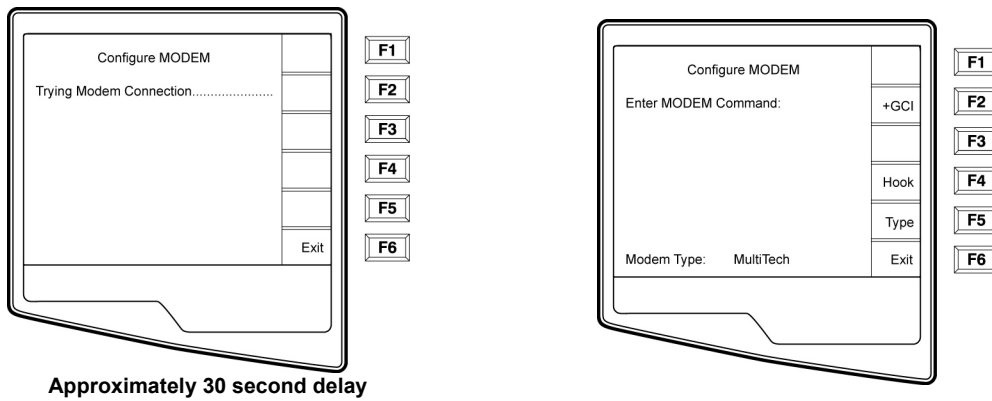

From the Configure Modem screen, select **F2 (+GCI=)** to populate the prefix “**AT+GCI**” of the modem command.

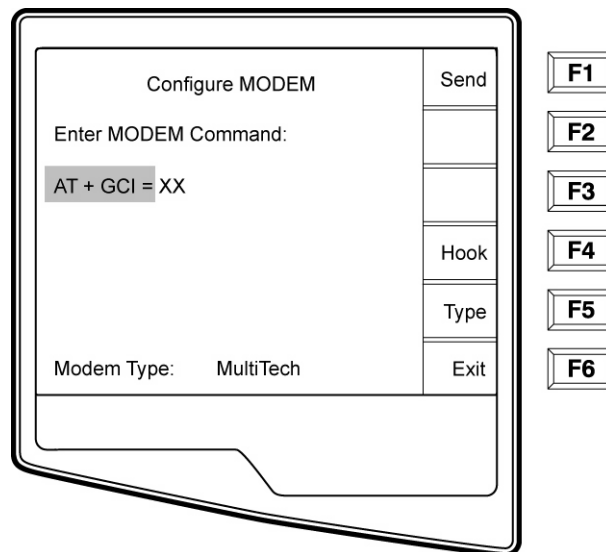

TIP: “**AT+GCI**” will be highlighted– cursor is not present – use keypad to enter country code.

The type of modem installed in your cardiograph is displayed at the bottom of the Configure Modem screen. Depending upon the type of modem, use the corresponding list below to enter your country code. Select **F1 (Send)** to change your country code. “Sending....” and “Command stored” will be displayed. Select **F6 (Exit)** to return to the ApplicationMenu.

XIRCOM MODEM COUNTRY CODE LIST:

Country	Code	Country	Code
Argentina	07	Liechtenstein	68
Australia	09	Luxembourg	69
Austria	0A	Japan	00
Barbados	0E	Korea	61
Belgium	0F	Malaysia	6C
Brazil	16	Mexico	73

Canada	20	Netherlands	7B
Czech Republic	2E	New Zealand	7E
China	26	Norway	82
Denmark	31	Poland	8A
Finland	3C	Portugal	8B
France	3D	Russia	B8
Germany	04	South Africa	9F
Greece	46	Singapore	9C
Guam	48	Slovak Republic	FC
Hungary	51	Spain	A0
Hong Kong	50	Sweden	A5
Iceland	52	Switzerland	A6
India	53	Taiwan	FE
Indonesia	54	Thailand	A9
Ireland	57	United Kingdom	B4
Israel	58	United States	B5
Italy	59	Venezuela	BB

Blind Dialing for Xircom Modems

Using the ATX3 command may support specific countries where the “wait for dial tone” often causes dialing/telephone issues. Following the steps outlined above, access the Configure Modem Screen. Using the keypad, enter **ATX3**. Select **F1 (Send)**. The following status messages will be displayed:

“Sending...”

“Command Stored”

“Reading Status, please wait.....”

The country code string will be

displayed. Press **F6 (Exit)**

MulitTech MODEM COUNTRYCODE LIST:

Country	Code	Country	Code
Argentina	07	Italy	FD
Australia	09	Japan	00
Austria	FD	Korea	B5
Belgium	FD	Liechtenstein	FD
Canada	B5	Luxembourg	FD
China	B5	Mexico	B5
Cyprus	FD	Netherlands	FD
Czech Republic	FD	New Zealand	7E
Denmark	FD	Norway	FD
Finland	FD	Philippines	B5
France	FD	Portugal	FD
Germany	FD	Slovak Republic	FD
Greece	FD	Spain	FD
Hong Kong	99	Sweden	FD
Hungary	FD	Switzerland	FD
Iceland	FD	Taiwan	FE
Indonesia	99	United Kingdom	FD
Ireland	FD	United States	B5

WLAN Transmission

For a WLAN transmission, set the Default XMT media to WLAN from Configuration page 6 (see System Settings section of this manual). It is necessary that the IT Manager of your facility configure the wireless access point(s) and E-Scribe

workstation. Also, it is required that your IT Manager set the ELI 250 WLAN configuration values. Refer to System Settings section for more information on WLAN configuration setup. The ELI 250 can be configured for DHCP (Dynamic Host Communication Protocol) and for WEP (Wired Equivalent Privacy) security.

NOTE: environmental conditions may affect the reliability of WLAN transmissions.

If DHCP is set to NO, your wireless access point will have a static network setting and the following parameters must be configured in the ELI 250:

IP Address
Def Gateway
Sub Net Mask

If DHCP is set to YES, your wireless access point will have an automatic network setting and IP Address, Def Gateway and Sub Net Mask do not need to be configured.

In either DHCP setting, the following wireless network parameters must be configured in the ELI 250 by your IT Manager:

Host IP
Port Number
SSID
Channel Number

Note: addresses are always entered as 4 sets of 3 digits; therefore, an address of 192.168.0.7 must be entered on the ELI 250 as 192.168.000.007.

If WEP Security is disabled on your access point then set Security (WEP) to NO. If WEP Security is enabled on your access point then the following wireless network parameters must be configured in the ELI 250 by the IT Manager:

Security (WEP): YES
WEP Key
WEP Key ID

Note: the range for the WEP Key on the ELI 250 is 0-3. If the range on your access point is 1-4, then 0 at the ELI 250 maps to 1 on the access point; 1 at the ELI 250 maps to 2 on the access point, etc.

LAN Transmission

For a LAN transmission, set the Default XMT media to LAN from Configuration page 6 (see System Settings section of this manual). It is necessary that the IT Manager of your facility set the ELI 250 LAN configuration values. Refer to System Settings section for more information on LAN configuration setup.

Note: addresses are always entered as 4 sets of 3 digits; therefore, an address of 192.168.0.7 must be entered on the ELI 250 as 192.168.000.007.

Connect the Ethernet cable to the LAN connection at the rear of the ELI 250, as pictured below.

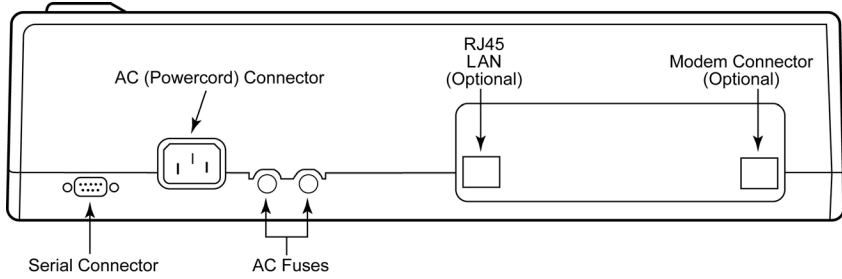

Caution: Possible damage to the cardiograph may occur if telephone cable is connected to the LAN connector.

Ethernet Status LEDs

At the external LAN interface connector, the user is presented with two LEDs (Light Emitting Diodes). The two status indicator LEDs provide signals for “link status” and “packet transmit/receive”. As the external connector is viewed from the outside, rear of the ELI 250, the left LED remains illuminated when the network link is detected. The ELI 250 LAN will support signaling rates of 10 and 100 MBPS. The right LED flashes when a transmit or receive packet occurs or any traffic on the network is detected.

Receive ECGs

To receive ECGs from another Welch Allyn electrocardiograph (using either a telephone or a direct connection), select **Receive ECGs (4)** from the Application Menu.

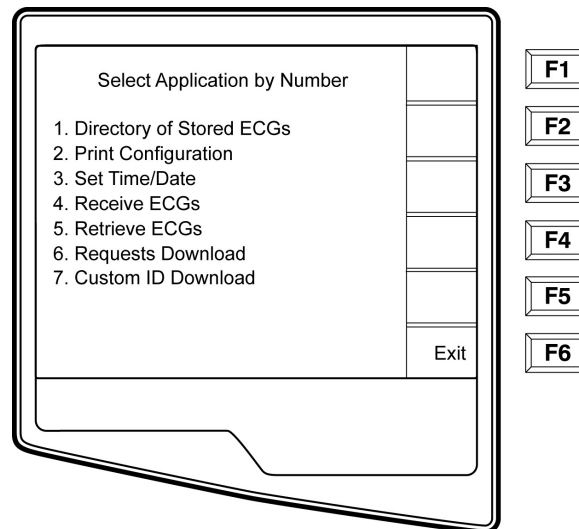

The LCD displays the following message:

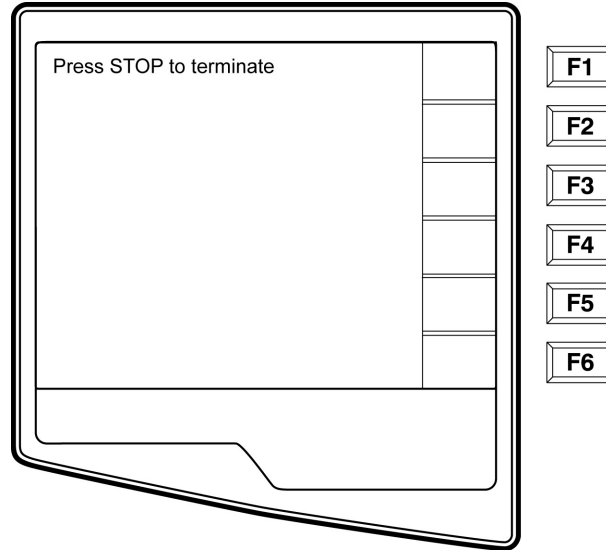

When the LCD displays the above message, the unit is ready to receive the ECGs from the transmitting electrocardiograph. Follow the instructions on transmitting records as described in this section. The receiving unit only acts as a printer. Received ECGs will not be viewed or stored. To terminate the receiving mode, press the **STOP** key.

Note: The ELI 250 will receive records from Welch Allyn model cardiographs except for Welch Allyn's Portrait. The Welch Allyn model cardiographs (ELI 100, ELI 200, Landscape, and Portrait) will not receive the ELI 250 records.

Retrieve ECGs

It is possible to retrieve ECGs from the E-Scribe Data Management System using any of the connectivity options. Before attempting to retrieve ECGs, please configure the Default XMT Media, the telephone number (if using modem transmission) and the site number (see System Settings section). Select **Retrieve ECGs (5)** from the Application Menu. The following screen appears:

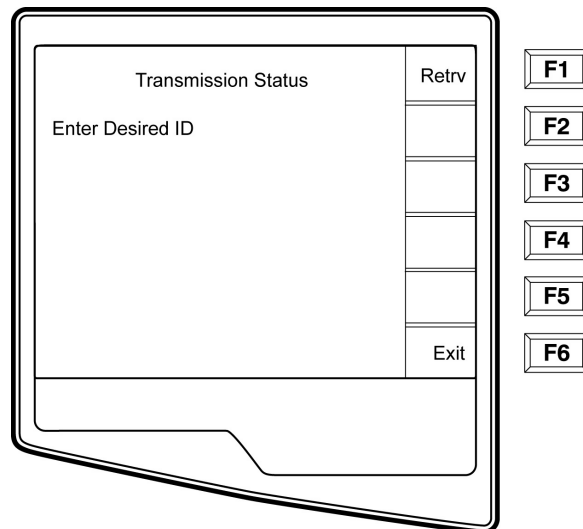

Note: The ID field defaults the last acquired ECG

ECGs are retrieved by ID number. Enter the desired ID and select **F1**. E-Scribe transmits the most recent ECG with the specified ID number (or the configured number of ECGs retrieved— refer to System Settings section). The ELI 250 prints the retrieved ECG(s) and returns to the Real-Time ECG View. Viewing and storing retrieved ECGs is not possible.

Requests Download

The ELI 250 can download and process a patient request list from the E-Scribe, which identifies the ECGs (or ECG orders) needed for particular patients. Request Codes are designed in your E-Scribe Data Management System, which contain the particular patients who require ECGs. The technician at the cardiograph selects the desired Request Code (e.g. a code specific to a department or floor) and does not have to enter the demographic information for the patients belonging to the Request Code. Once downloaded, the patient list for each Request Code is stored in the cardiograph as the Request List (similar to the patient directory). As with the other forms of ECG data transmission, you can use either the optional modem or a direct connection. Follow the hookup instructions under Transmitting Records in this section.

NOTE: A Custom ID must be downloaded before downloading the Requests (please reference the E-Scribe Operator Manual and Custom ID Format of this Section).

From the Real Time ECG View, select **F6 (More)** to display the Application Menu.

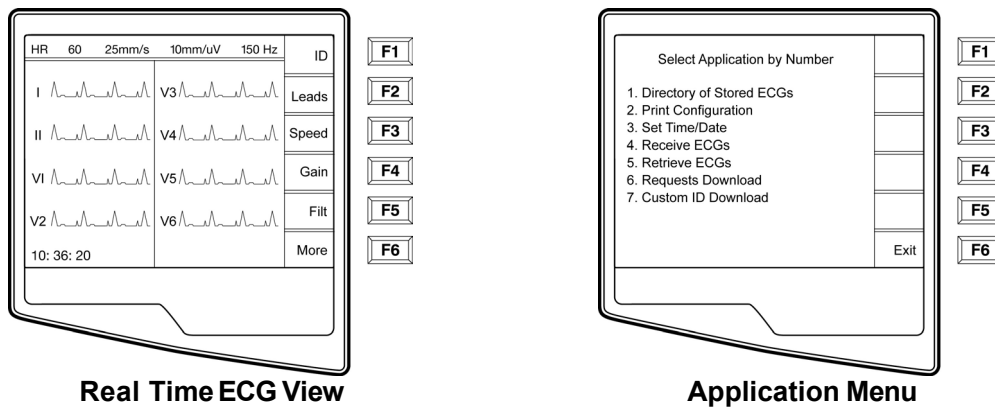

From the Application Menu, select number **6 (Requests Download)** and the following screen is displayed:

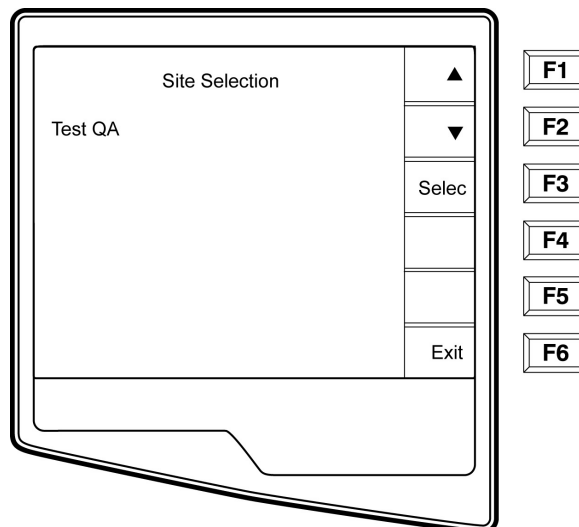

Under the heading “Site Selection”, the Request Code is displayed. Use F1 (**F1**) and (**F2**) to scroll through the available Request Codes. Request Codes are only available if a Custom ID has been downloaded. Once you find the desired Request Code, Select **F3 (Select)** to download the Requests and the following screen appears:

NOTE: A Custom ID must be downloaded before downloading the Requests.

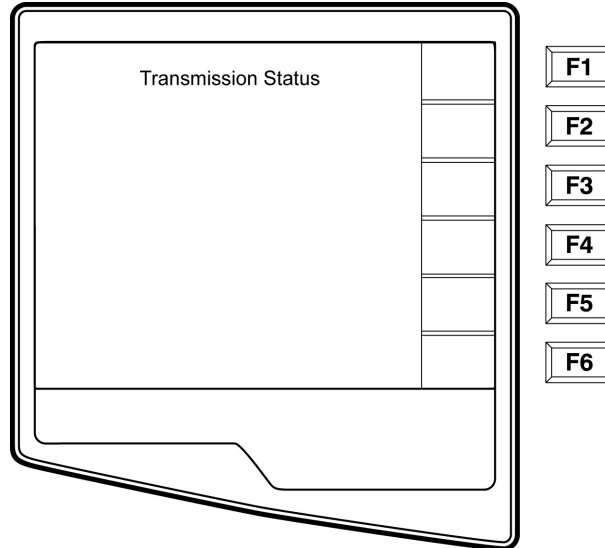

“Transmission Status” will be displayed for approximately 10 seconds followed by “Dialing: telephone number”, “Waiting for Response”, and “Connected”. Once connected, the following screen indicates the number of Requests received (patients) for the Request Code. This only appears briefly and returns to the Real Time ECG View.

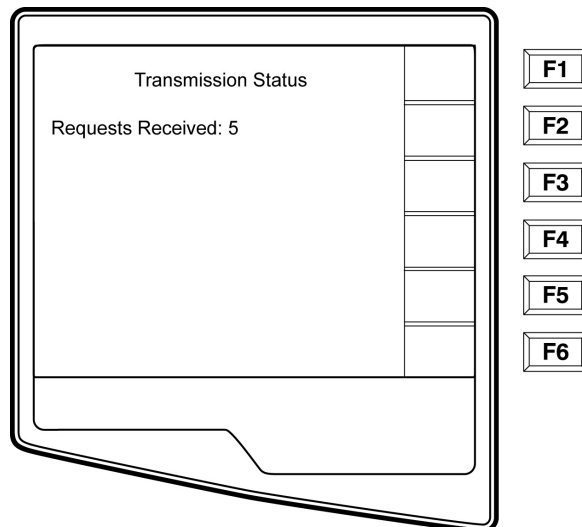

When the Request List has been downloaded, you may select the patients who need ECGs. Select **ID (F1)** from the Real-Time ECG View.

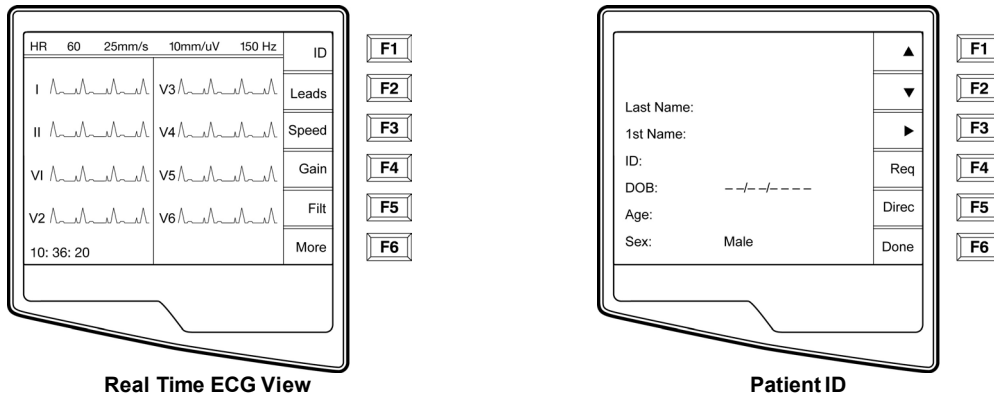

Patient RequestList

Select **Req (F4)** from the Patient ID screen and the Patient Request List is displayed. The Patient Request List is comparable to the Patient Directory in looks and in practice. The Patient Request List (sorted by name) is pictured below.

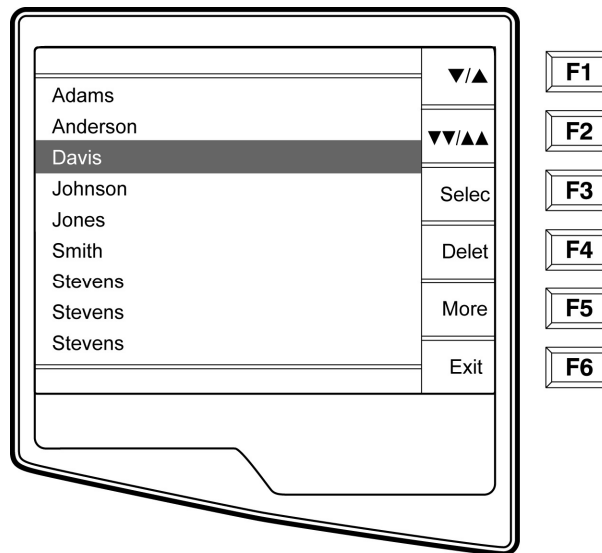

Similar to the Directory of stored ECGs, the Patient RequestList is easily sorted either by Name, ID, or Date. To sort the Requests, select **More (F5)** from the Patient Request List.

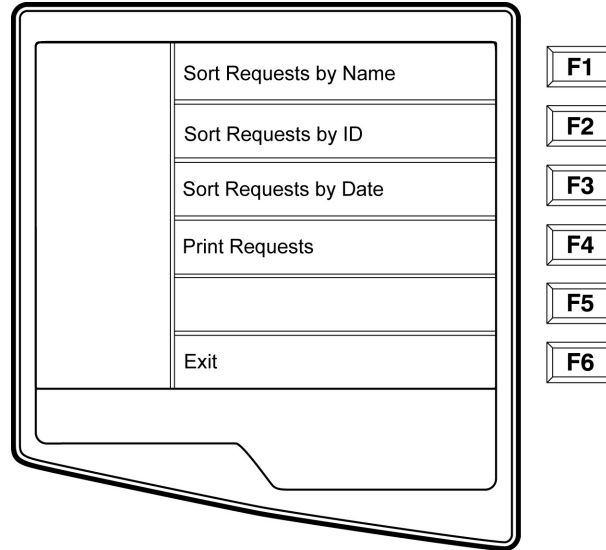

Select **F1** to sort the requests by patient name (ID, time & date are displayed on the top row)

Select **F2** to sort the requests by patient ID (name is displayed on the top row)

Select **F3** to sort the requests by acquisition date (name is displayed on the top row)

To make a printout of the Patient Requests List, select **Print Requests (F4)**. **Exit (F6)** to return to the Patient Requests List.

Use **(F1)** to navigate down the Patient Request List and **Shift (F1)** to move up the list. Similarly, use **(F2)** to page down and **Shift (F2)** to page up through the Request List. To quickly select a patient name, use the keyboard to enter the first letter of the last name. Once the desired name is highlighted, press **Select (F3)** and the patient ID screen will return with all demographic fields populated. Return to Real-Time ECG View by selecting **Done (F6)**. Once the ECG is acquired, the patient will be automatically removed from the Patient Request List and the ECG will be stored in the Patient Directory.

Custom ID Download

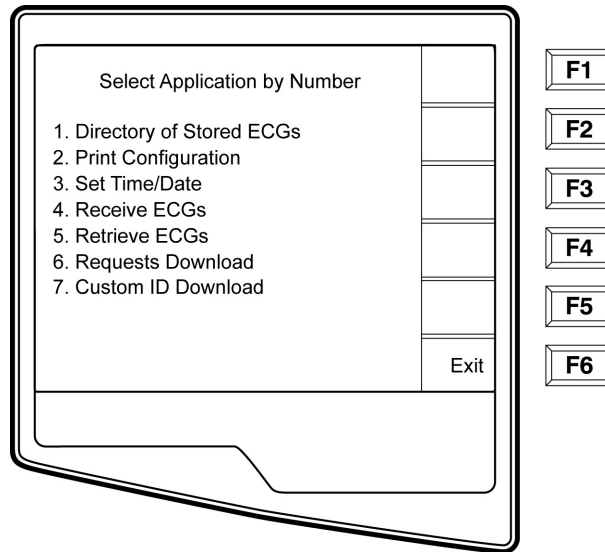

Custom ID formats are uniquely defined by your facility's needs. This customized ECG header information is designed in the Welch Allyn E-Scribe data management system and downloaded to the ELI250 as the Group Name either by serial connection (direct) or modem transmission.

Select **Custom ID Download (7)** from the Application menu and the following screen appears:

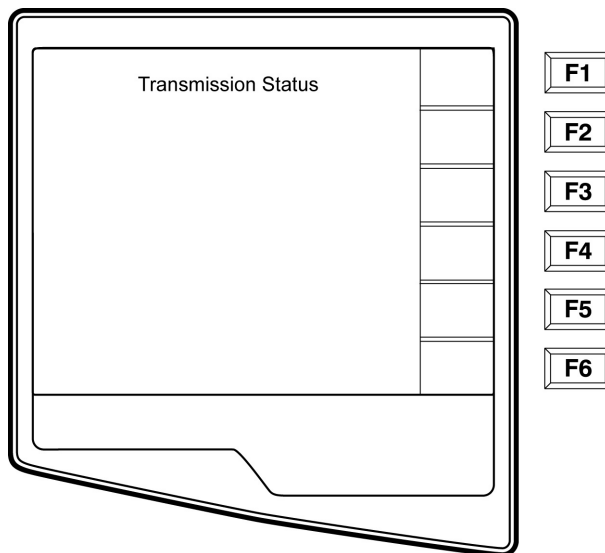

“Transmission Status” will remain visible for approximately 10 seconds before the following screen appears:

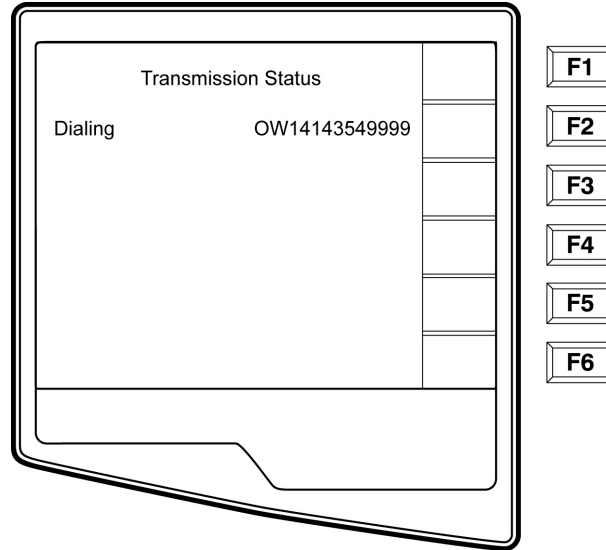

“Waiting for Response”, “Connected”, and “Custom ID downloaded” will be displayed before returning to the Real-Time ECG View, which indicates the Custom ID download is complete. The new Custom ID becomes the customized header format for all future ECGs until you select a different ID format in the configuration settings. You may alter the ID format configuration to Short, Standard, Long or Custom based on your patient demographic entry needs. The Custom ID is only deleted upon downloading a new Custom ID or on the rare occasion of downloading software – it will not be lost due to power loss or switching to a different ID format.

TIP: Upon Custom ID download, the ID format will assume the group name as designed in the E-Scribe.

NOTE: A Custom ID must be downloaded before downloading the Request Codes (please reference the E-Scribe Operator Manual).

NOTE: The site number must be configured in the cardiograph and recognized as an established, valid site number at the E-Scribe before downloading the custom ID.

TIP: Confirm the baud rate in the configuration settings before downloading the custom ID from the E-Scribe.

Appendix B ELI 250 Connectivity Options

Modem Options

There are two possible modems that the ELI 250 can contain. The first is the *XIRCOM* modem and the second is the *Multitech* modem. Each modem is an internal modem. The *Xircom* modem is a PCMCIA modem and must be placed into the bottom slot of the motherboards PCMCIA connector. The *Multitech* modem is a separate card that mounts to the chassis of the ELI250 near the back of the unit (see Multitech Modem section of this appendix).

Please note that only one modem can be used at a time and the country codes for the modems are different.

XIRCOM Modem

The XIRCOM modem, item # 55, is a PCMCIA type modem that is inserted into the bottom slot of the PCMCIA connector of the motherboard.



Xircom Modem Removal

1. Remove the top cover and the writer assembly.
2. Locate the mounting screws, item#48, and bracket, item# 42, for the modem and remove them.

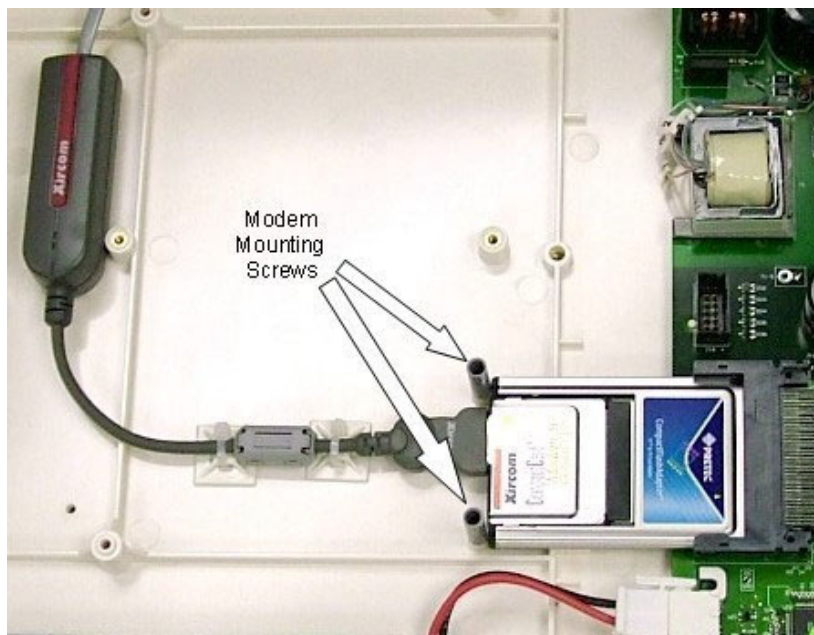

3. Remove the cable, part of item# 55, connected directly to the modem. If needed cut the cable ties, item# 63, that hold this cable to the chassis of the unit. Note: When replacing the modem remember to replace the cable ties. This will prevent the cable from coming loose from the modem.
4. Slide the modem card out of the PCMCIA slot.
5. Installation of replacement card is done in reverse order.

Multitech Modem

The Multitech modem is a separate board, item#61, installed near the rear of the ELI 250 unit. There is one ribbon cable, item#62, that connects the motherboard to the Modem Interface board. This cable connects power and data to the modem.



Multitech Modem Removal

1. Remove the top cover and the writer assembly.
2. Remove the ribbon cable, item# 62, and telephone patch cord, item#56, cables from the Modem Interface Board, item#61.

3. Locate the 4 mounting screws, item # 45, for the modem and remove them.

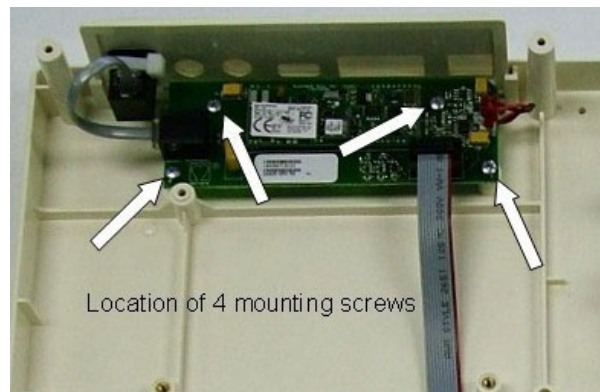

4. The Modem Interface Board should lift out of the unit.
5. Install the new or replacement board in the reverse order.

LAN Option

The LAN, Local Area Network, option consists of two circuit boards and two interconnect cables. The first card, the LAN card (item #57) occupies the top slot of the PCMCIA slots on the motherboard. The second board is the LAN interface board, item #58, and is mounted inside the chassis near the rear of the unit.

LAN Card Removal

To remove the LAN Card from the unit follow these steps

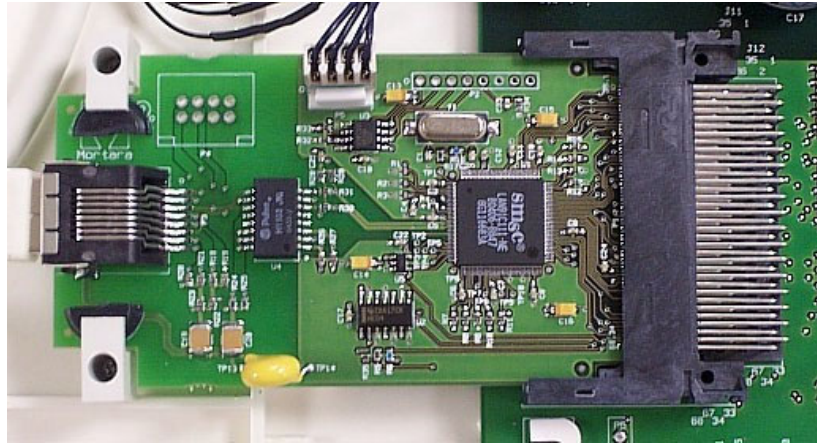

1. Open the unit to access the motherboard.
2. Locate the LAN card, item #57, connected to the PCMCIA slot on the motherboard.
3. Remove the two cables, item #'s 59 and 60, that connect the LAN card to the LAN Interface board.
4. Remove the two self-tapping screws, item # 48, and retaining Ebracket, item # 42.

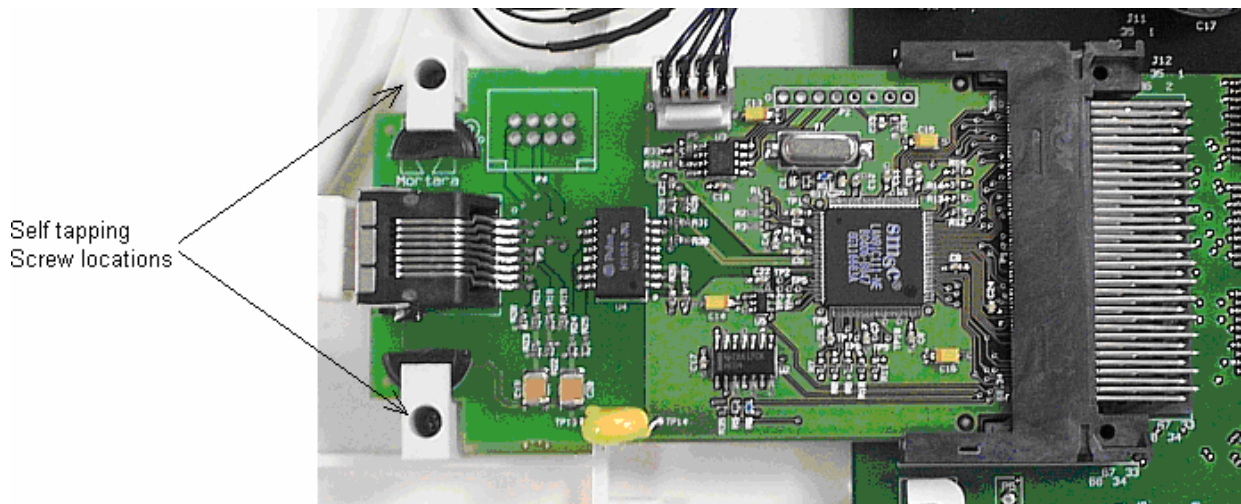

5. Slide the LAN card out of the PCMCIA slot of the motherboard.
6. Reinstall the card in the reverse order.

Removal of the LAN Interface Board, item#58.

1. Open the unit to access the motherboard
2. Locate the LAN Interface board. Item number 58, near the back of the unit.

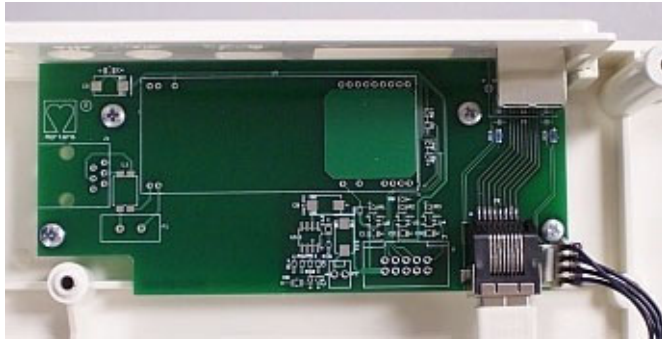

3. Remove the cables, item #'s 59 and 60, from the LAN Interface board.
4. Locate the 4 mounting screw, item#45 for the LAN Interface board and remove.

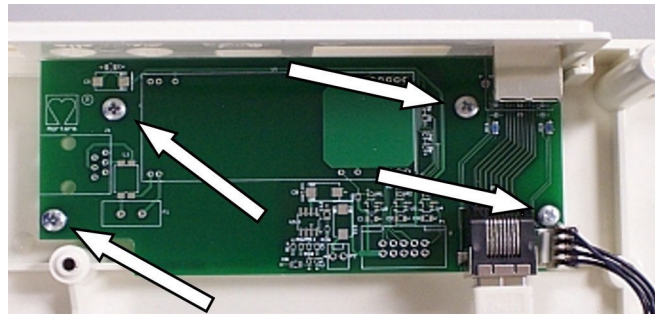

5. Reassemble unit in reverse order

LAN Card Interconnect cables.

The picture below shows the positions of the LAN Interconnect cables, items 58 and 59. Please note that the cables are tie wrapped, item# 63, to the chassis of the unit to prevent the cables from coming in contact with the motherboard. The cables must be tie wrapped to the chassis in the locations shown to maintain the electrical safety of the unit.

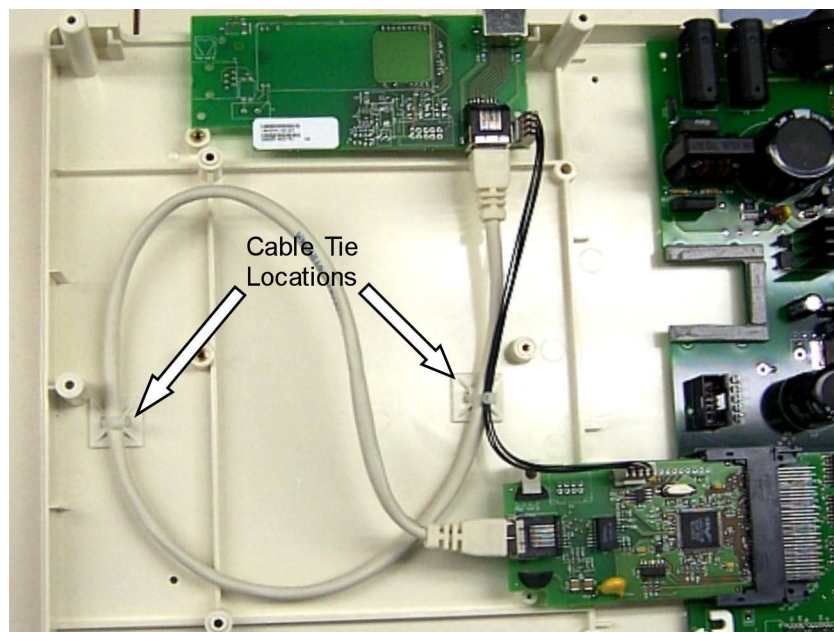
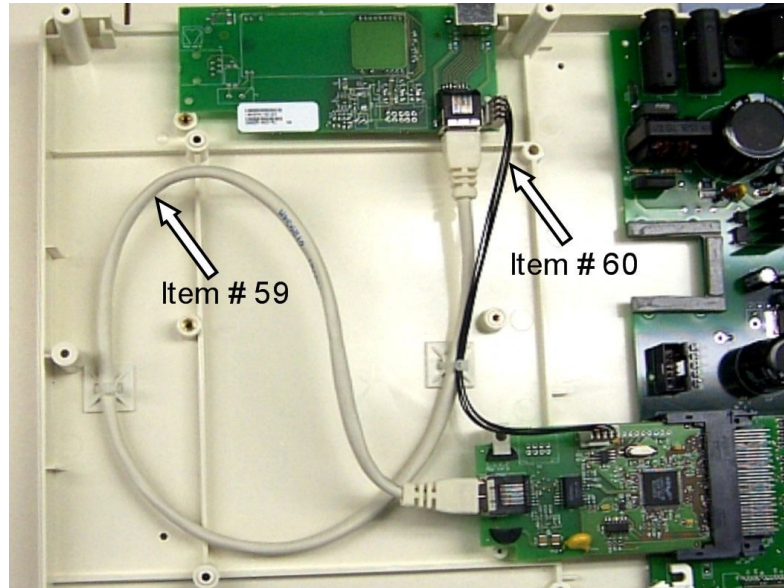

Note: The cables going from the LAN card to the LAN interface board must be routed away from the motherboard to ensure electrical safety of the unit.

Wireless LAN Option

The Wireless LAN option is a PCMCIA card that connects to the bottom slot of the PCMCIA connector of the motherboard.



Wireless LAN card (WLAN) Removal

1. Open the unit to access the motherboard.
2. Locate the WLAN card, item number 41, connected to the PCMCIA slot on the motherboard.
3. Remove the E-clip, Item #42 and 48, that retains the WLAN card.

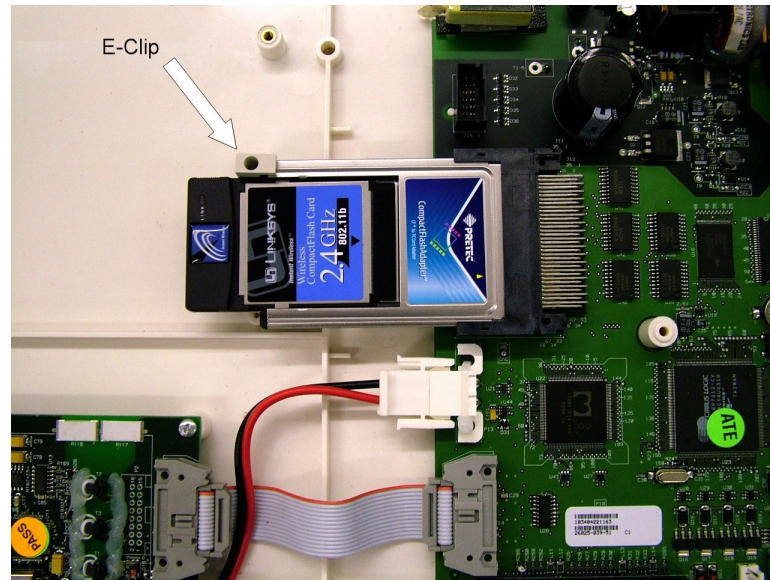

4. Slide the WLAN card out of the PCMCIA slot.
5. Reassemble unit in reverse order.